

# PowerFlex 520-Series Adjustable Frequency AC Drive

PowerFlex 523 Catalog Number 25A

PowerFlex 525 Catalog Number 25B

This Quick Start guide summarizes the basic steps needed to install, start-up and program the PowerFlex 520-Series Adjustable Frequency AC Drive. **The information provided DOES NOT replace the User Manual and is intended for qualified drive service personnel only.** For detailed PowerFlex 520-Series information including EMC instructions, application considerations and related precautions, see the PowerFlex 520-Series User Manual, publication [520-UM001](#).

Topic	Page
<a href="#">General Precautions</a>	<a href="#">2</a>
<a href="#">Mounting Considerations</a>	<a href="#">3</a>
<a href="#">Fuses and Circuit Breakers</a>	<a href="#">6</a>
<a href="#">Technical Specifications</a>	<a href="#">8</a>
<a href="#">Power Wiring</a>	<a href="#">9</a>
<a href="#">I/O Wiring</a>	<a href="#">10</a>
<a href="#">Control Terminal Block</a>	<a href="#">11</a>
<a href="#">Prepare For Drive Start-Up</a>	<a href="#">15</a>
<a href="#">Network Communication</a>	<a href="#">33</a>

## Additional Resources

These documents contain additional information concerning related products from Rockwell Automation.

Title	Publication
PowerFlex 520-Series Adjustable Frequency AC Drive User Manual	<a href="#">520-UM001</a>
PowerFlex 4-Class Human Interface Module (HIM) DSI Quick Reference	<a href="#">22HIM-QR001</a>
PowerFlex 525 Embedded EtherNet/IP Adapter User Manual	<a href="#">520COM-UM001</a>
PowerFlex 25-COMM-D DeviceNet Adapter User Manual	<a href="#">520COM-UM002</a>
PowerFlex 25-COMM-E2P EtherNet/IP Adapter User Manual	<a href="#">520COM-UM003</a>
PowerFlex 25-COMM-P PROFIBUS DP Adapter User Manual	<a href="#">520COM-UM004</a>
Dynamic Braking Resistor Calculator	<a href="#">PFLEX-AT001</a>
Wiring and Grounding Guidelines for PWM AC Drives	<a href="#">DRIVES-IN001</a>
Preventive Maintenance of Industrial Control and Drive System Equipment	<a href="#">DRIVES-TD001</a>
Safety Guidelines for the Application, Installation and Maintenance of Solid State Control	<a href="#">SGI-1.1</a>

You can view or download publications at <http://www.rockwellautomation.com/literature/>. To order paper copies of technical documentation, contact your local Allen-Bradley distributor or Rockwell Automation sales representative.



**ATTENTION:**

- **Before installing, configuring, operating or maintaining this product, read this document and the documents listed in the Additional Resources section for installing, configuring, or operating equipment. Users should familiarize themselves with installation and wiring instructions in addition to requirements of all applicable codes, laws, and standards.**
  - Installation, adjustments, putting into service, use, assembly, disassembly, and maintenance shall be carried out by suitably trained personnel in accordance with applicable code of practice.
  - If this equipment is used in a manner not specified by the manufacturer, the protection provided by the equipment may be impaired.
  - Solid state equipment has operational characteristics differing from those of electromechanical equipment. Safety Guidelines for the Application, Installation and Maintenance of Solid State Controls, publication SGI-1.1, available from your local Rockwell Automation sales office or online at <http://www.rockwellautomation.com/literature> describes some important differences between solid state equipment and hard-wired electromechanical devices.
- 

## General Precautions

---



**ATTENTION:** The drive contains high voltage capacitors which take time to discharge after removal of mains supply. Before working on drive, ensure isolation of mains supply from line inputs [R, S, T (L1, L2, L3)]. Wait three minutes for capacitors to discharge to safe voltage levels. Failure to do so may result in personal injury or death. Darkened display LEDs is not an indication that capacitors have discharged to safe voltage levels.

**ATTENTION:** Only qualified personnel familiar with adjustable frequency AC drives and associated machinery should plan or implement the installation, start-up and subsequent maintenance of the system. Failure to comply may result in personal injury and/or equipment damage.

**ATTENTION:** This drive contains ESD (Electrostatic Discharge) sensitive parts and assemblies. Static control precautions are required when installing, testing, servicing or repairing this assembly. Component damage may result if ESD control procedures are not followed. If you are not familiar with static control procedures, reference A-B publication 8000-4.5.2, "Guarding Against Electrostatic Damage" or any other applicable ESD protection handbook.

**ATTENTION:** An incorrectly applied or installed drive can result in component damage or a reduction in product life. Wiring or application errors, such as undersizing the motor, incorrect or inadequate AC supply, or excessive ambient temperatures may result in malfunction of the system.

**ATTENTION:** The bus regulator function is extremely useful for preventing nuisance overvoltage faults resulting from aggressive decelerations, overhauling loads, and eccentric loads. However, it can also cause either of the following two conditions to occur.

1. Fast positive changes in input voltage or imbalanced input voltages can cause uncommanded positive speed changes;
2. Actual deceleration times can be longer than commanded deceleration times

However, a "Stall Fault" is generated if the drive remains in this state for 1 minute. If this condition is unacceptable, the bus regulator must be disabled (see parameter A550 [Bus Reg Enable]). In addition, installing a properly sized dynamic brake resistor will provide equal or better performance in most cases.

**ATTENTION:** Risk of injury or equipment damage exists. Drive does not contain user-serviceable components. Do not disassemble drive chassis.

---

# Mounting Considerations

- Mount the drive upright on a flat, vertical and level surface.

Frame	Screw Size	Screw Torque
A	M5 (#10...24)	1.56...1.96 Nm (14...17 lb-in.)
B	M5 (#10...24)	1.56...1.96 Nm (14...17 lb-in.)
C	M5 (#10...24)	1.56...1.96 Nm (14...17 lb-in.)
D	M5 (#10...24)	2.45...2.94 Nm (22...26 lb-in.)
E	M8 (5/16 in.)	6.0...7.4 Nm (53...65 lb-in.)

- Protect the cooling fan by avoiding dust or metallic particles.
- Do not expose to a corrosive atmosphere.
- Protect from moisture and direct sunlight.

# Minimum Mounting Clearances

See [Dimensions and Weight on page 32](#) for mounting dimensions.

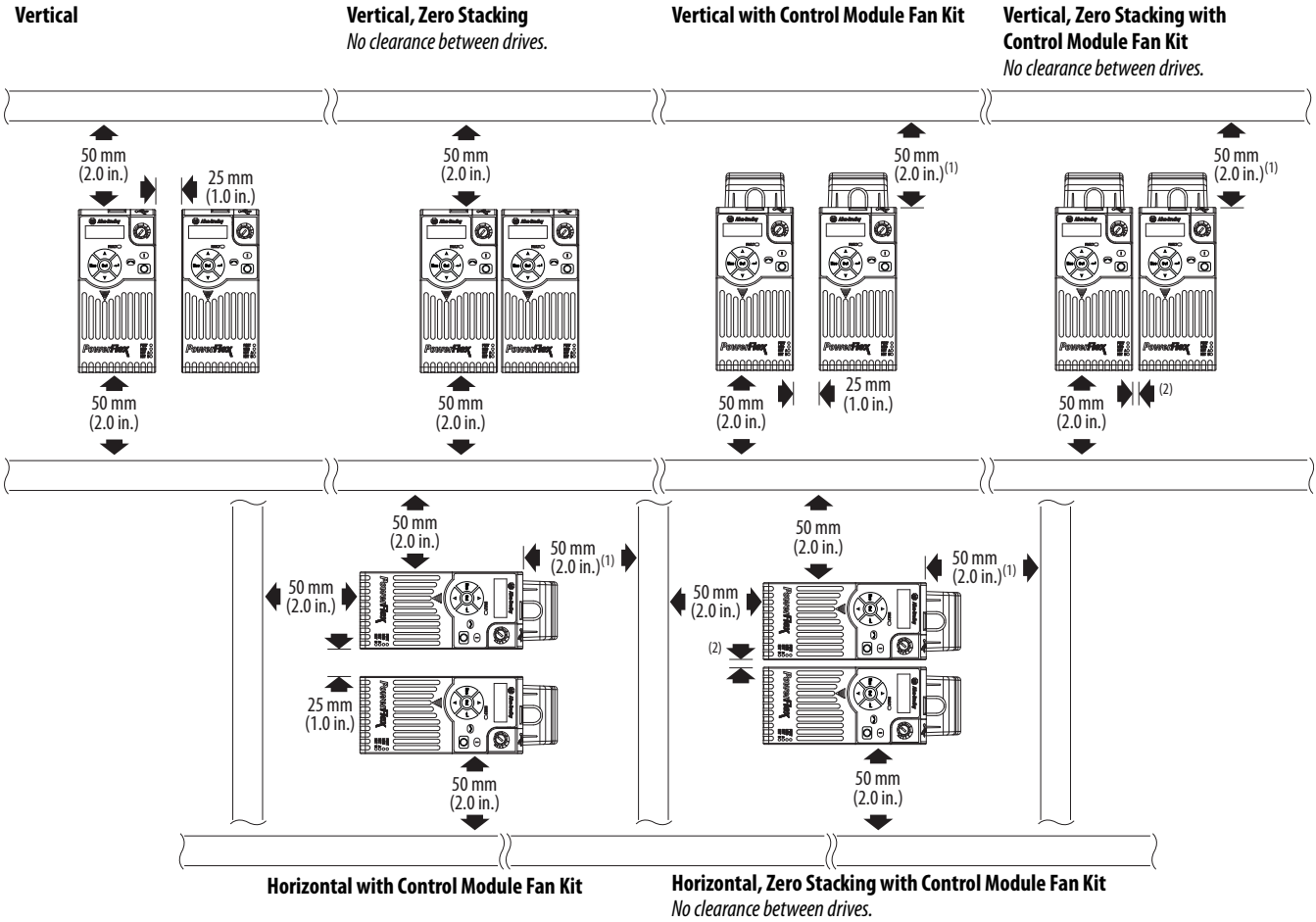

(1) For Frame E with Control Module Fan Kit only, clearance of 95 mm (3.7 in.) is required.  
 (2) For Frame E with Control Module Fan Kit only, clearance of 12 mm (0.5 in.) is required.

## Ambient Operating Temperatures

See Appendix B of the PowerFlex 520-Series User Manual, publication [520-UM001](#) for option kits.

Mounting	Enclosure Rating <sup>(3)</sup>	Ambient Temperature			
		Minimum	Maximum (No Derate)	Maximum (Derate) <sup>(4)</sup>	Maximum with Control Module Fan Kit (Derate) <sup>(2) (5)</sup>
Vertical	IP 20/Open Type	-20 °C (-4 °F)	50 °C (122 °F)	60 °C (140 °F)	70 °C (158 °F)
	IP 30/NEMA 1/UL Type 1		45 °C (113 °F)	55 °C (131 °F)	–
Vertical, Zero Stacking	IP 20/Open Type		45 °C (113 °F)	55 °C (131 °F)	65 °C (149 °F)
	IP 30/NEMA 1/UL Type 1		40 °C (104 °F)	50 °C (122 °F)	–
Horizontal with Control Module Fan Kit <sup>(1) (2)</sup>	IP 20/Open Type		50 °C (122 °F)	–	70 °C (158 °F)
Horizontal, Zero Stacking with Control Module Fan Kit <sup>(1) (2)</sup>	IP 20/Open Type		45 °C (113 °F)	–	65 °C (149 °F)

- (1) Catalogs 25x-D1P4N104 and 25x-E0P9N104 cannot be mounted using either of the horizontal mounting methods.
- (2) Requires installation of the PowerFlex 520-Series Control Module Fan Kit, catalog number 25-FANx-70C.
- (3) IP 30/NEMA 1/UL Type 1 rating requires installation of the PowerFlex 520-Series IP 30/NEMA 1/UL Type 1 option kit, catalog number 25-JBAX.
- (4) For catalogs 25x-D1P4N104 and 25x-E0P9N104, the temperature listed under the Max. (Derate) column is reduced by 5 °C (9 °F) for all mounting methods.
- (5) For catalogs 25x-D1P4N104 and 25x-E0P9N104, the temperature listed under the Max. with Control Module Fan Kit (Derate) column is reduced by 10 °C (18 °F) for vertical and vertical with zero stacking mounting methods only.

## General Grounding Requirements

The drive Safety Ground – (PE) must be connected to system ground. Ground impedance must conform to the requirements of national and local industrial safety regulations and/or electrical codes. The integrity of all ground connections should be periodically checked.

### Typical Grounding

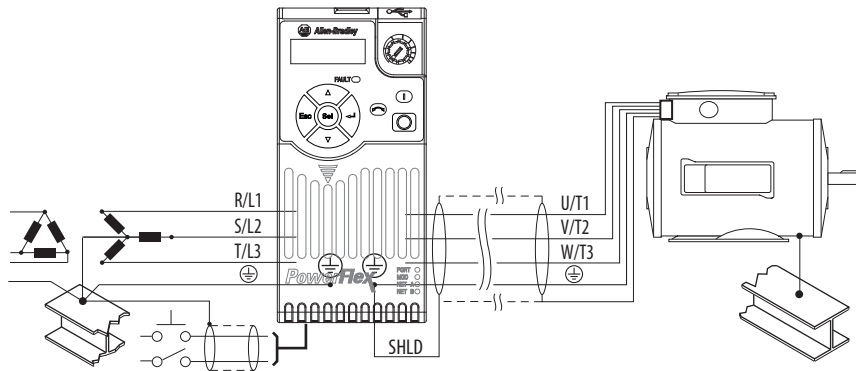

## Ungrounded Distribution Systems



**ATTENTION:** PowerFlex 520-Series drives contain protective MOVs that are referenced to ground. These devices must be disconnected if the drive is installed on an ungrounded or resistive grounded distribution system.

**ATTENTION:** Removing MOVs in drives with an embedded filter will also disconnect the filter capacitor from earth ground.

### Disconnecting MOVs

To prevent drive damage, the MOVs connected to ground shall be disconnected if the drive is installed on an ungrounded distribution system (IT mains) where the line-to-ground voltages on any phase could exceed 125% of the nominal line-to-line voltage. To disconnect these devices, remove the jumper shown in the diagrams below.

1. Turn the screw counterclockwise to loosen.
2. Pull the jumper completely out of the drive chassis.
3. Tighten the screw to keep it in place.

### Jumper Location (Typical)

Power Module

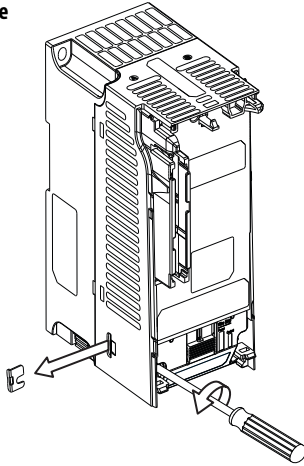

**IMPORTANT** Tighten screw after jumper removal.

### Phase to Ground MOV Removal

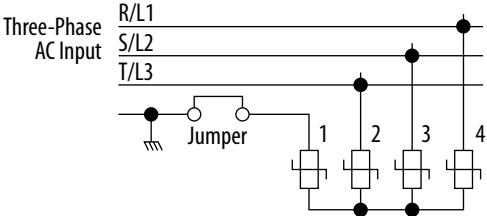

### CE Conformity

See the PowerFlex 520-Series Adjustable Frequency AC Drive User Manual, publication [520-UM001](#) for details on how to comply with the Low Voltage (LV) and Electromagnetic Compatibility (EMC) Directives.

## Fuses and Circuit Breakers

Catalog No. <sup>(1)</sup>		Output Ratings				Input Ratings				Branch Circuit Protection			Min. Enclosure Volume (in. <sup>3</sup> )	IP 20 Open Type Watts Loss
PowerFlex 523	PowerFlex 525	Normal Duty		Heavy Duty		Amps	Voltage Range	kVA	Max Amps <sup>(2)</sup>	Fuse Ratings Min/Max	Contactors	140M Motor Protectors (3) (4) (5)		
		HP	kW	HP	kW									
<b>100...120V AC (-15%, +10%) – 1-Phase Input, 0...230V 3-Phase Output</b>														
25A-V1P6N104	–	0.25	0.2	0.25	0.2	1.6	85...132	0.8	6.4	10/16	100-C09	140M-C2E-B63	–	20.0
25A-V2P5N104	25B-V2P5N104	0.5	0.4	0.5	0.4	2.5	85...132	1.3	9.6	16/20	100-C12	140M-C2E-C10	–	27.0
25A-V4P8N104	25B-V4P8N104	1.0	0.75	1.0	0.75	4.8	85...132	2.5	19.2	25/40	100-C23	140M-D8E-C20	–	53.0
25A-V6P0N104	25B-V6P0N104	1.5	1.1	1.5	1.1	6.0	85...132	3.2	24.0	32/50	100-C23	140M-F8E-C25	–	67.0
<b>200...240V AC (-15%, +10%) – 1-Phase Input, 0...230V 3-Phase Output</b>														
25A-A1P6N104	–	0.25	0.2	0.25	0.2	1.6	170...264	1.4	5.3	6/10	100-C09	140M-C2E-B63	–	20.0
25A-A2P5N104	25B-A2P5N104	0.5	0.4	0.5	0.4	2.5	170...264	1.7	6.5	10/16	100-C09	140M-C2E-C10	–	29.0
25A-A4P8N104	25B-A4P8N104	1.0	0.75	1.0	0.75	4.8	170...264	2.8	10.7	16/25	100-C12	140M-C2E-C16	–	50.0
25A-A8P0N104	25B-A8P0N104	2.0	1.5	2.0	1.5	8.0	170...264	4.8	18.0	25/40	100-C23	140M-F8E-C25	–	81.0
25A-A011N104	25B-A011N104	3.0	2.2	3.0	2.2	11.0	170...264	6.0	22.9	32/50	100-C37	140M-F8E-C25	–	111.0
<b>200...240V AC (-15%, +10%) – 1-Phase Input with EMC Filter, 0...230V 3-Phase Output</b>														
25A-A1P6N114	–	0.25	0.2	0.25	0.2	1.6	170...264	1.4	5.3	6/10	100-C09	140M-C2E-B63	–	20.0
25A-A2P5N114	25B-A2P5N114	0.5	0.4	0.5	0.4	2.5	170...264	1.7	6.5	10/16	100-C09	140M-C2E-C10	–	29.0
25A-A4P8N114	25B-A4P8N114	1.0	0.75	1.0	0.75	4.8	170...264	2.8	10.7	16/25	100-C12	140M-C2E-C16	–	53.0
25A-A8P0N114	25B-A8P0N114	2.0	1.5	2.0	1.5	8.0	170...264	4.8	18.0	25/40	100-C23	140M-F8E-C25	–	84.0
25A-A011N114	25B-A011N114	3.0	2.2	3.0	2.2	11.0	170...264	6.0	22.9	32/50	100-C37	140M-F8E-C25	–	116.0
<b>200...240V AC (-15%, +10%) – 3-Phase Input, 0...230V 3-Phase Output</b>														
25A-B1P6N104	–	0.25	0.2	0.25	0.2	1.6	170...264	0.9	1.9	3/6	100-C09	140M-C2E-B25	–	20.0
25A-B2P5N104	25B-B2P5N104	0.5	0.4	0.5	0.4	2.5	170...264	1.2	2.7	6/6	100-C09	140M-C2E-B40	–	29.0
25A-B5P0N104	25B-B5P0N104	1.0	0.75	1.0	0.75	5.0	170...264	2.7	5.8	10/16	100-C09	140M-C2E-B63	–	50.0
25A-B8P0N104	25B-B8P0N104	2.0	1.5	2.0	1.5	8.0	170...264	4.3	9.5	16/20	100-C12	140M-C2E-C10	–	79.0
25A-B011N104	25B-B011N104	3.0	2.2	3.0	2.2	11.0	170...264	6.3	13.8	20/32	100-C23	140M-C2E-C16	–	107.0
25A-B017N104	25B-B017N104	5.0	4.0	5.0	4.0	17.5	170...264	9.6	21.1	32/45	100-C23	140M-F8E-C25	–	148.0
25A-B024N104	25B-B024N104	7.5	5.5	7.5	5.5	24.0	170...264	12.2	26.6	35/63	100-C37	140M-F8E-C32	–	259.0
25A-B032N104	25B-B032N104	10.0	7.5	10.0	7.5	32.2	170...264	15.9	34.8	45/70	100-C43	140M-F8E-C45	–	323.0
25A-B048N104	25B-B048N104	15.0	11.0	10.0	7.5	48.3	170...264	20.1	44.0	63/90	100-C60	140M-F8E-C45	1416.0 <sup>(7)</sup>	584.0
25A-B062N104	25B-B062N104	20.0	15.0	15.0	11.0	62.1	170...264	25.6	56.0	70/125	100-C72	–	–	708.0
<b>380...480V AC (-15%, +10%) – 3-Phase Input, 0...460V 3-Phase Output</b>														
25A-D1P4N104	25B-D1P4N104	0.5	0.4	0.5	0.4	1.4	323...528	1.7	1.9	3/6	100-C09	140M-C2E-B25	–	27.0
25A-D2P3N104	25B-D2P3N104	1.0	0.75	1.0	0.75	2.3	323...528	2.9	3.2	6/10	100-C09	140M-C2E-B40	–	37.0
25A-D4P0N104	25B-D4P0N104	2.0	1.5	2.0	1.5	4.0	323...528	5.2	5.7	10/16	100-C09	140M-C2E-B63	–	80.0
25A-D6P0N104	25B-D6P0N104	3.0	2.2	3.0	2.2	6.0	323...528	6.9	7.5	10/16	100-C09	140M-C2E-C10	–	86.0
25A-D010N104	25B-D010N104	5.0	4.0	5.0	4.0	10.5	323...528	12.6	13.8	20/32	100-C23	140M-C2E-C16	–	129.0
25A-D013N104	25B-D010N104	7.5	5.5	7.5	5.5	13.0	323...528	14.1	15.4	20/35	100-C23	140M-D8E-C20	–	170.0
25A-D017N104	25B-D017N104	10.0	7.5	10.0	7.5	17.0	323...528	16.8	18.4	25/40	100-C23	140M-D8E-C20	–	221.0
25A-D024N104	25B-D024N104	10.0	7.5	10.0	7.5	17.0	323...528	24.1	26.4	35/63	100-C37	140M-F8E-C32	656.7 <sup>(7)</sup>	221.0
25A-D030N104	25B-D030N104	20.0	15.0	15.0	11.0	30.0	323...528	30.2	33.0	45/70	100-C43	140M-F8E-C45	656.7 <sup>(7)</sup>	387.0
<b>380...480V AC (-15%, +10%) – 3-Phase Input with EMC Filter, 0...460V 3-Phase Output</b>														
25A-D1P4N114	25B-D1P4N114	0.5	0.4	0.5	0.4	1.4	323...528	1.7	1.9	3/6	100-C09	140M-C2E-B25	–	27.0
25A-D2P3N114	25B-D2P3N114	1.0	0.75	1.0	0.75	2.3	323...528	2.9	3.2	6/10	100-C09	140M-C2E-B40	–	37.0
25A-D4P0N114	25B-D4P0N114	2.0	1.5	2.0	1.5	4.0	323...528	5.2	5.7	10/16	100-C09	140M-C2E-B63	–	81.0
25A-D6P0N114	25B-D6P0N114	3.0	2.2	3.0	2.2	6.0	323...528	6.9	7.5	10/16	100-C09	140M-C2E-C10	–	88.0
25A-D010N114	25B-D010N114	5.0	4.0	5.0	4.0	10.5	323...528	12.6	13.8	20/32	100-C23	140M-C2E-C16	–	133.0

Catalog No. <sup>(1)</sup>		Output Ratings					Input Ratings			Branch Circuit Protection			Min. Enclosure Volume (in. <sup>3</sup> )	IP 20 Open Type Watts Loss
PowerFlex 523	PowerFlex 525	Normal Duty		Heavy Duty		Amps	Voltage Range	kVA	Max Amps <sup>(2)</sup>	Fuse Ratings Min/Max	Contactors	140M Motor Protectors <sup>(3) (4) (5)</sup>		
		HP	kW	HP	kW									
25A-D013N114	25B-D013N114	7.5	5.5	7.5	5.5	13.0	323...528	14.1	15.4	20/35	100-C23	140M-D8E-C20	–	175.0
25A-D017N114	25B-D017N114	10.0	7.5	10.0	7.5	17.0	323...528	16.8	18.4	25/40	100-C23	140M-D8E-C20	–	230.0
25A-D024N114	25B-D024N114	15.0	11.0	15.0	11.0	24.0	323...528	24.1	26.4	35/63	100-C37	140M-F8E-C32	656.7 <sup>(7)</sup>	313.0
25A-D030N114	25B-D030N114	20.0	15.0	15.0	11.0	30.0	323...528	30.2	33.0	45/70	100-C43	140M-F8E-C45	656.7 <sup>(7)</sup>	402.0
25A-D037N114	25B-D037N114	25.0	18.5	20.0	15.0	37.0	323...528	30.8	33.7	45/70	100-C43	140M-F8E-C45	–	602.0
25A-D043N114	25B-D043N114	30.0	22.0	25.0	18.5	43.0	323...528	35.6	38.9	50/80	100-C60	140M-F8E-C45	–	697.0
<b>525...600V AC (-15%, +10%) – 3-Phase Input, 0...575V 3-Phase Output</b>														
25A-E0P9N104	25B-E0P9N104	0.5	0.4	0.5	0.4	0.9	446...660	1.4	1.2	3/6	100-C09	140M-C2E-B25	–	22.0
25A-E1P7N104	25B-E1P7N104	1.0	0.75	1.0	0.75	1.7	446...660	2.6	2.3	3/6	100-C09	140M-C2E-B25	–	32.0
25A-E3P0N104	25B-E3P0N104	2.0	1.5	2.0	1.5	3.0	446...660	4.3	3.8	6/10	100-C09	140M-C2E-B40	–	50.0
25A-E4P2N104	25B-E4P2N104	3.0	2.2	3.0	2.2	4.2	446...660	6.1	5.3	10/16	100-C09	140M-D8E-B63	–	65.0
25A-E6P6N104	25B-E6P6N104	5.0	4.0	5.0	4.0	6.6	446...660	9.1	8.0	10/20	100-C09	140M-D8E-C10	–	95.0
25A-E9P9N104	25B-E9P9N104	7.5	5.5	7.5	5.5	9.9	446...660	12.8	11.2	16/25	100-C16	140M-D8E-C16 <sup>(6)</sup>	–	138.0
25A-E012N104	25B-E012N104	10.0	7.5	10.0	7.5	12.0	446...660	15.4	13.5	20/32	100-C23	140M-D8E-C16	–	164.0
25A-E019N104	25B-E019N104	15.0	11.0	15.0	11.0	19.0	446...660	27.4	24.0	32/50	100-C30	140M-F8E-C25	656.7 <sup>(7)</sup>	290.0
25A-E022N104	25B-E022N104	20.0	15.0	15.0	11.0	22.0	446...660	31.2	27.3	35/63	100-C30	140M-F8E-C32	656.7 <sup>(7)</sup>	336.0
25A-E027N104	25B-E027N104	25.0	18.5	20.0	15.0	27.0	446...660	28.2	24.7	35/50	100-C30	140M-F8E-C32	1416.0 <sup>(7)</sup>	466.0
25A-E032N104	25B-E032N104	30.0	22.0	25.0	18.5	32.0	446...660	33.4	29.2	40/63	100-C37	140M-F8E-C32	1416.0 <sup>(7)</sup>	562.0

(1) ■ Normal Duty (ND) and Heavy Duty (HD) ratings are available for this drive.

(2) When the drive is controlling motors with lower amp ratings, refer to the drive nameplate for drive input current rating.

(3) The AIC ratings of the Bulletin 140M Motor Protector Circuit Breakers may vary. See Bulletin 140M Motor Protection Circuit Breakers Application Ratings.

(4) Bulletin 140M with adjustable current range should have the current trip set to the minimum range that the device will not trip.

(5) Manual Self-Protected (Type E) Combination Motor Controller, UL listed for 480Y/277 and 600Y/347 AC input. Not UL listed for use on 480V or 600V Delta/Delta, corner ground, or high-resistance ground systems.

(6) When used with the 140M circuit breaker, the 25A-E9P9104 must be installed in a ventilated or non-ventilated enclosure with the minimum size of 457.2 x 457.2 x 269.8 mm (18 x 18 x 10.62 in.).

(7) When using a Manual Self-Protected (Type E) Combination Motor Controller with this drive power rating, the drive must be installed in a ventilated or non-ventilated enclosure with the minimum volume specified in this column. Application specific thermal considerations may require a larger enclosure.

# Technical Specifications

## PowerFlex 523 Specifications

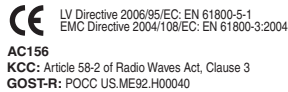
<b>Input/Output Ratings</b>		<b>Digital Control Inputs (Input Current = 6 mA)</b>		<b>Approvals</b>  
Output Frequency: 0...500 Hz (Programmable) Efficiency: 97.5% (Typical)		SRC (Source) Mode: 18...24V = ON 0...6V = OFF	SNK (Sink) Mode: 0...6V = ON 18...24V = OFF	
<b>Control Output</b>		<b>Analog Control Inputs</b>		<b>Fuses and Circuit Breakers</b>
Programmable Output, Form C Resistive Rating: 3.0 A @ 30V DC, 125V AC and 240V AC Inductive Rating: 0.5 A @ 30V DC, 125V AC and 240V AC		4-20 mA Analog: 250 Ω input impedance 0-10V DC Analog: 100 kΩ input impedance External Pot: 1...10 kΩ, 2 W min.		Recommended Fuse Type: UL Class CC, J, T or Type BS88; 600V (550V) or equivalent. Recommended Circuit Breakers: HMCP or equivalent.
<b>Protective Features</b>				
Motor Protection: I <sup>2</sup> t overload protection – 150% for 60 s, 200% for 3 s (Provides Class 10 protection)				
Overcurrent: 200% hardware limit, 300% instantaneous fault				
Over Voltage: 100...120V AC Input – Trip occurs @ 405V DC bus voltage (equivalent to 150V AC incoming line) 200...240V AC Input – Trip occurs @ 405V DC bus voltage (equivalent to 290V AC incoming line) 380...480V AC Input – Trip occurs @ 810V DC bus voltage (equivalent to 575V AC incoming line) 525...600V AC Input – Trip occurs @ 1005V DC bus voltage (equivalent to 711V AC incoming line)				
Under Voltage: 100...120V AC Input – Trip occurs @ 190V DC bus voltage (equivalent to 75V AC incoming line) 200...240V AC Input – Trip occurs @ 190V DC bus voltage (equivalent to 150V AC incoming line) 380...480V AC Input – Trip occurs @ 390V DC bus voltage (equivalent to 275V AC incoming line) 525...600V AC Input – If P038 = 3 “600V” trip occurs @ 487V DC bus voltage (344V AC incoming line); – If P038 = 2 “480V” trip occurs @ 390V DC bus voltage (275V AC incoming line)				
Control Ride Through: Minimum ride through is 0.5 s - typical value 2 s				
Faultless Power Ride Through: 100 ms				

## PowerFlex 525 Specifications

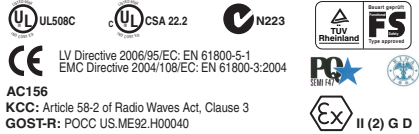
<b>Input/Output Ratings</b>		<b>Approvals</b>		
Output Frequency: 0...500 Hz (Programmable) Efficiency: 97.5% (Typical)				
<b>Digital Control Inputs (Input Current = 6 mA)</b>		<b>Analog Control Inputs</b>		<b>Fuses and Circuit Breakers</b>
SRC (Source) Mode: 18...24V = ON 0...6V = OFF	SNK (Sink) Mode: 0...6V = ON 18...24V = OFF	4-20 mA Analog: 250 Ω input impedance 0-10V DC Analog: 100 kΩ input impedance External Pot: 1...10 kΩ, 2 W min.		Recommended Fuse Type: UL Class J, T or Type BS88; 600V (550V) or equivalent. Recommended Circuit Breakers: HMCP or equivalent.
<b>Control Output</b>		<b>Opto Outputs</b>		<b>Analog Outputs (10-bit)</b>
Programmable Output, Form A and Form B Resistive Rating: 3.0 A @ 30V DC, 125V AC and 240V AC Inductive Rating: 0.5 A @ 30V DC, 125V AC and 240V AC		30V DC, 50 mA Non-inductive		0-10V: 1 kΩ min. 4-20 mA: 525 Ω max.
<b>Protective Features</b>				
Motor Protection: I <sup>2</sup> t overload protection – 150% for 60 s, 200% for 3 s (Provides Class 10 protection)				
Overcurrent: 200% hardware limit, 300% instantaneous fault				
Over Voltage: 100...120V AC Input – Trip occurs @ 405V DC bus voltage (equivalent to 150V AC incoming line) 200...240V AC Input – Trip occurs @ 405V DC bus voltage (equivalent to 290V AC incoming line) 380...480V AC Input – Trip occurs @ 810V DC bus voltage (equivalent to 575V AC incoming line) 525...600V AC Input – Trip occurs @ 1005V DC bus voltage (equivalent to 711V AC incoming line)				
Under Voltage: 100...120V AC Input – Trip occurs @ 190V DC bus voltage (equivalent to 75V AC incoming line) 200...240V AC Input – Trip occurs @ 190V DC bus voltage (equivalent to 150V AC incoming line) 380...480V AC Input – Trip occurs @ 390V DC bus voltage (equivalent to 275V AC incoming line) 525...600V AC Input – If P038 = 3 “600V” trip occurs @ 487V DC bus voltage (344V AC incoming line); – If P038 = 2 “480V” trip occurs @ 390V DC bus voltage (275V AC incoming line)				
Control Ride Through: Minimum ride through is 0.5 s – typical value 2 s				
Faultless Power Ride Through: 100 ms				



# Power Wiring

## Recommended Shielded Wire

Location	Rating/Type	Description
Standard (Option 1)	600V, 90 °C (194 °F) XHHW2/RHW-2 Anixter B209500-B209507, Belden 29501-29507, or equivalent	<ul style="list-style-type: none"> <li>Four tinned copper conductors with XLPE insulation.</li> <li>Copper braid/aluminum foil combination shield and tinned copper drain wire.</li> <li>PVC jacket.</li> </ul>
Standard (Option 2)	Tray rated 600V, 90 °C (194 °F) RHH/RHW-2 Anixter OLF-7xxxx or equivalent	<ul style="list-style-type: none"> <li>Three tinned copper conductors with XLPE insulation.</li> <li>5 mil single helical copper tape (25% overlap min.) with three bare copper grounds in contact with shield.</li> <li>PVC jacket.</li> </ul>
Class I & II; Division I & II	Tray rated 600V, 90 °C (194 °F) RHH/RHW-2 Anixter 7V-7xxxx-3G or equivalent	<ul style="list-style-type: none"> <li>Three bare copper conductors with XLPE insulation and impervious corrugated continuously welded aluminum armor.</li> <li>Black sunlight resistant PVC jacket overall.</li> <li>Three copper grounds on #10 AWG and smaller.</li> </ul>

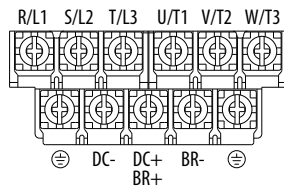

## Power Terminal Block Diagrams and Wiring Specifications

### Frame A...D

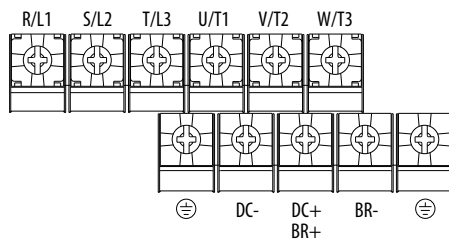

### Frame E

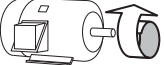

Terminal	Description
R/L1, S/L2	1-Phase Input Line Voltage Connection
R/L1, S/L2, T/L3	3-Phase Input Line Voltage Connection
U/T1, V/T2, W/T3	Motor Phase Connection =  Switch any two motor leads to change forward direction.
DC+, DC-	DC Bus Connection (except for 110V 1-Phase)
BR+, BR-	Dynamic Brake Resistor Connection
	Safety Ground – PE

Frame	Maximum Wire Size <sup>(1)</sup>	Minimum Wire Size <sup>(1)</sup>	Torque
A	5.3 mm <sup>2</sup> (10 AWG)	0.8 mm <sup>2</sup> (18 AWG)	1.76...2.16 Nm (15.6...19.1 lb-in.)
B	8.4 mm <sup>2</sup> (8 AWG)	2.1 mm <sup>2</sup> (14 AWG)	1.76...2.16 Nm (15.6...19.1 lb-in.)
C	8.4 mm <sup>2</sup> (8 AWG)	2.1 mm <sup>2</sup> (14 AWG)	1.76...2.16 Nm (15.6...19.1 lb-in.)
D	13.3 mm <sup>2</sup> (6 AWG)	5.3 mm <sup>2</sup> (10 AWG)	1.76...2.16 Nm (15.6...19.1 lb-in.)
E	26.7 mm <sup>2</sup> (3 AWG)	8.4 mm <sup>2</sup> (8 AWG)	3.09...3.77 Nm (27.3...33.4 lb-in.)

(1) Maximum/minimum sizes that the terminal block will accept – these are not recommendations.

## Input Power Conditions

Input Power Condition	Corrective Action
Low Line Impedance (less than 1% line reactance)	<ul style="list-style-type: none"> <li>Install Line Reactor<sup>(2)</sup></li> <li>or Isolation Transformer</li> </ul>
Greater than 120 kVA supply transformer	
Line has power factor correction capacitors	
Line has frequent power interruptions	
Line has intermittent noise spikes in excess of 6000V (lightning)	
Phase to ground voltage exceeds 125% of normal line to line voltage	<ul style="list-style-type: none"> <li>Remove MOV jumper to ground.</li> <li>or Install Isolation Transformer with grounded secondary if necessary.</li> </ul>
Ungrounded distribution system	
240V open delta configuration (stinger leg) <sup>(1)</sup>	Install Line Reactor <sup>(2)</sup>

(1) For drives applied on an open delta with a middle phase grounded neutral system, the phase opposite the phase that is tapped in the middle to the neutral or earth is referred to as the "stinger leg," "high leg," "red leg," etc. This leg should be identified throughout the system with red or orange tape on the wire at each connection point. The stinger leg should be connected to the center Phase B on the reactor. See Appendix B of the PowerFlex 520-Series Adjustable Frequency AC Drive User Manual, publication [520-UM001](#) for specific line reactor part numbers.

(2) See Appendix B of the PowerFlex 520-Series Adjustable Frequency AC Drive User Manual, publication [520-UM001](#) for accessory ordering information.

## I/O Wiring

### Recommended Signal Wire

Signal Type/ Where Used	Belden Wire Type (or equivalent) <sup>(1)</sup>	Description	Minimum Insulation Rating
Analog I/O & PTC	8760/9460	0.750 mm <sup>2</sup> (18 AWG), twisted pair, 100% shield with drain <sup>(2)</sup>	300V, 60 °C (140 °F)
Remote Pot	8770	0.750 mm <sup>2</sup> (18 AWG), 3 conductor, shielded	
Encoder/Pulse I/O	9728/9730	0.196 mm <sup>2</sup> (24 AWG), individually shielded pairs	

(1) Stranded or solid wire.

(2) If the wires are short and contained within a cabinet which has no sensitive circuits, the use of shielded wire may not be necessary, but is always recommended.

### Recommended Control Wire for Digital I/O

Type	Wire Type(s)	Description	Minimum Insulation Rating
Unshielded	Per US NEC or applicable national or local code	–	300V, 60 °C (140 °F)
Unshielded	Multi-conductor shielded cable such as Belden 8770 (or equivalent)	0.750 mm <sup>2</sup> (18 AWG), 3 conductor, shielded.	

### Control I/O Terminal Block Wire Specifications

Frame	Maximum Wire Size <sup>(1)</sup>	Minimum Wire Size <sup>(1)</sup>	Torque
A...E	1.3 mm <sup>2</sup> (16 AWG)	1.3 mm <sup>2</sup> (16 AWG)	0.71...0.86 Nm (6.2...7.6 lb-in.)

(1) Maximum/minimum sizes that the terminal block will accept – these are not recommendations.

See the PowerFlex 520-Series Adjustable Frequency AC Drive User Manual, publication [520-UM001](#) for recommendations on maximum power and control cable length.

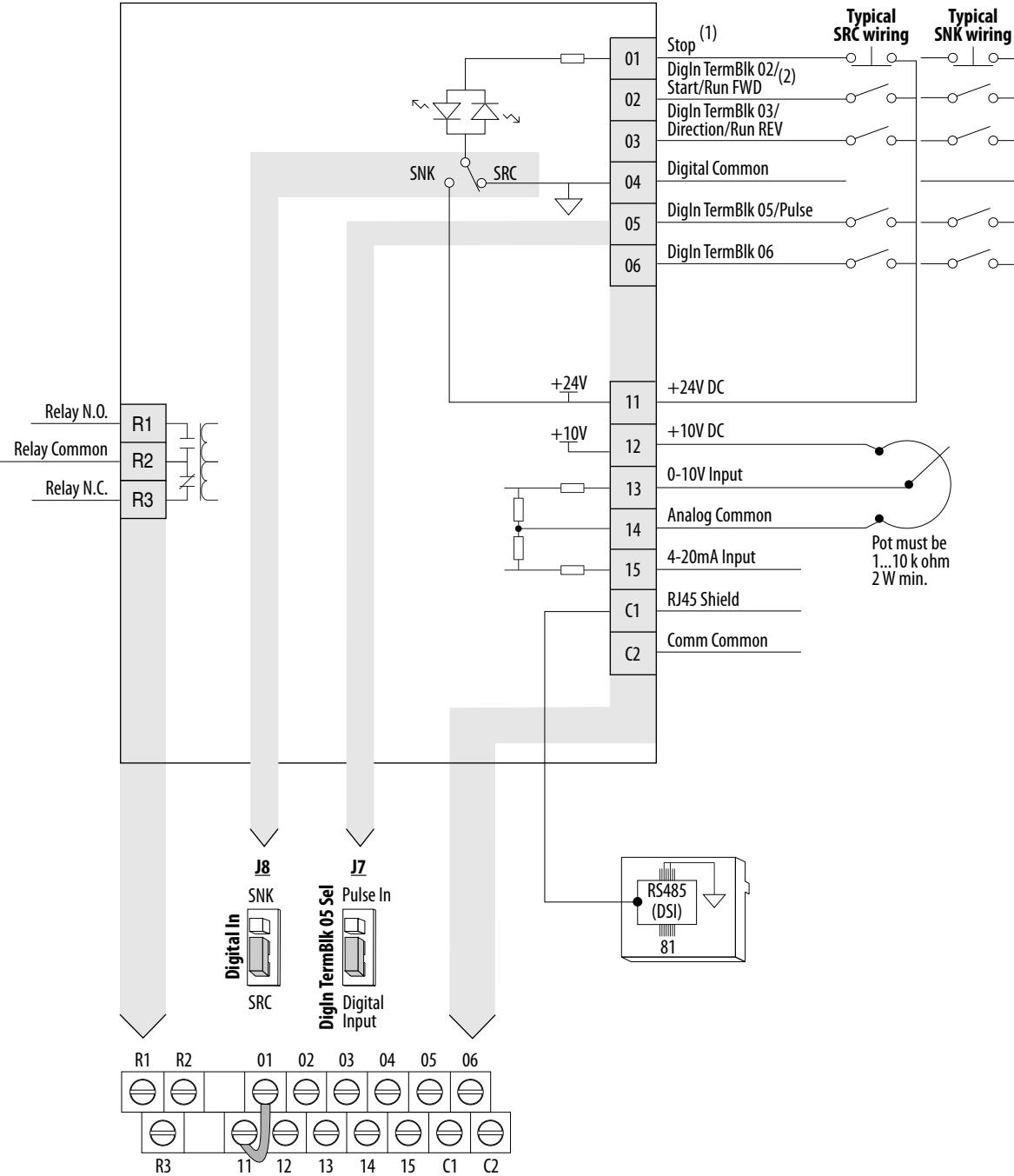

# Control Terminal Block

## PowerFlex 523 Control I/O Wiring Block Diagram



(1)

**IMPORTANT** I/O Terminal 01 is always a stop input. The stopping mode is determined by the drive setting. The drive is shipped with a jumper installed between I/O Terminals 01 and 11. Remove this jumper when using I/O Terminal 01 as a stop or enable input.

(2) Two wire control shown. For three wire control use a momentary input  on I/O Terminal 02 to command a start. Use a maintained input  for I/O Terminal 03 to change direction.  
 (3) Only one analog frequency source may be connected at a time. If more than one reference is connected at the same time, an undetermined frequency reference will result.

**PowerFlex 523 Control I/O Terminal Designations**

No.	Signal	Default	Description	Parameter
R1	Relay N.O.	Fault	Normally open contact for output relay.	t076
R2	Relay Common	Fault	Common for output relay.	t081
R3	Relay N.C.	Motor Running	Normally closed contact for output relay.	P045
01	Stop	Coast	Three wire stop. However, it functions as a stop under all input modes and cannot be disabled.	P045, P046, P048, P050, A544, t062
02	DigIn TermBlk 02/ Start/Run FWD	Run FWD	Used to initiate motion and also can be used as a programmable digital input. It can be programmed with t062 [DigIn TermBlk 02] as three wire (Start/Dir with Stop) or two wire (Run FWD/Run REV) control. Current consumption is 6 mA.	t063
03	DigIn TermBlk 03/ Dir/Run REV	Run REV	Used to initiate motion and also can be used as a programmable digital input. It can be programmed with t063 [DigIn TermBlk 03] as three wire (Start/Dir with Stop) or two wire (Run FWD/Run REV) control. Current consumption is 6 mA.	t063
04	Digital Common	–	Return for digital I/O. Electrically isolated (along with the digital I/O) from the rest of the drive.	–
05	DigIn TermBlk 05/ Pulse In	Preset Freq	Program with t065 [DigIn TermBlk 05]. Also functions as a Pulse Train input for reference or speed feedback. The maximum frequency is 100 kHz. Current consumption is 6 mA.	t065
06	DigIn TermBlk 06	Preset Freq	Program with t066 [DigIn TermBlk 06]. Current consumption is 6 mA.	t066
11	+24V DC	–	Referenced to Digital Common. Drive supplied power for digital inputs. Maximum output current is 100 mA.	–
12	+10V DC	–	Referenced to Analog Common. Drive supplied power for 0...10V external potentiometer. Maximum output current is 15 mA.	P047, P049
13	0-10V In <sup>(1)</sup>	Not Active	For external 0-10V (unipolar) input supply or potentiometer wiper. Input impedance: Voltage source = 100 kW Allowable potentiometer resistance range = 1...10 kW	P047, P049, t062, t063, t065, t066, t093, A459, A471
14	Analog Common	–	Return for the analog I/O. Electrically isolated (along with the analog I/O) from the rest of the drive.	–
15	4-20mA In <sup>(1)</sup>	Not Active	For external 4-20 mA input supply. Input impedance = 250 W	P047, P049, t062, t063, t065, t066, A459, A471
C1	C1	–	This terminal is tied to the RJ-45 port shield. Tie this terminal to a clean ground in order to improve noise immunity when using external communication peripherals.	–
C2	C2	–	This is the signal common for the communication signals.	–

(1) Only one analog frequency source may be connected at a time. If more than one reference is connected at the same time, an undetermined frequency reference will result.

# PowerFlex 525 Control I/O Wiring Block Diagram

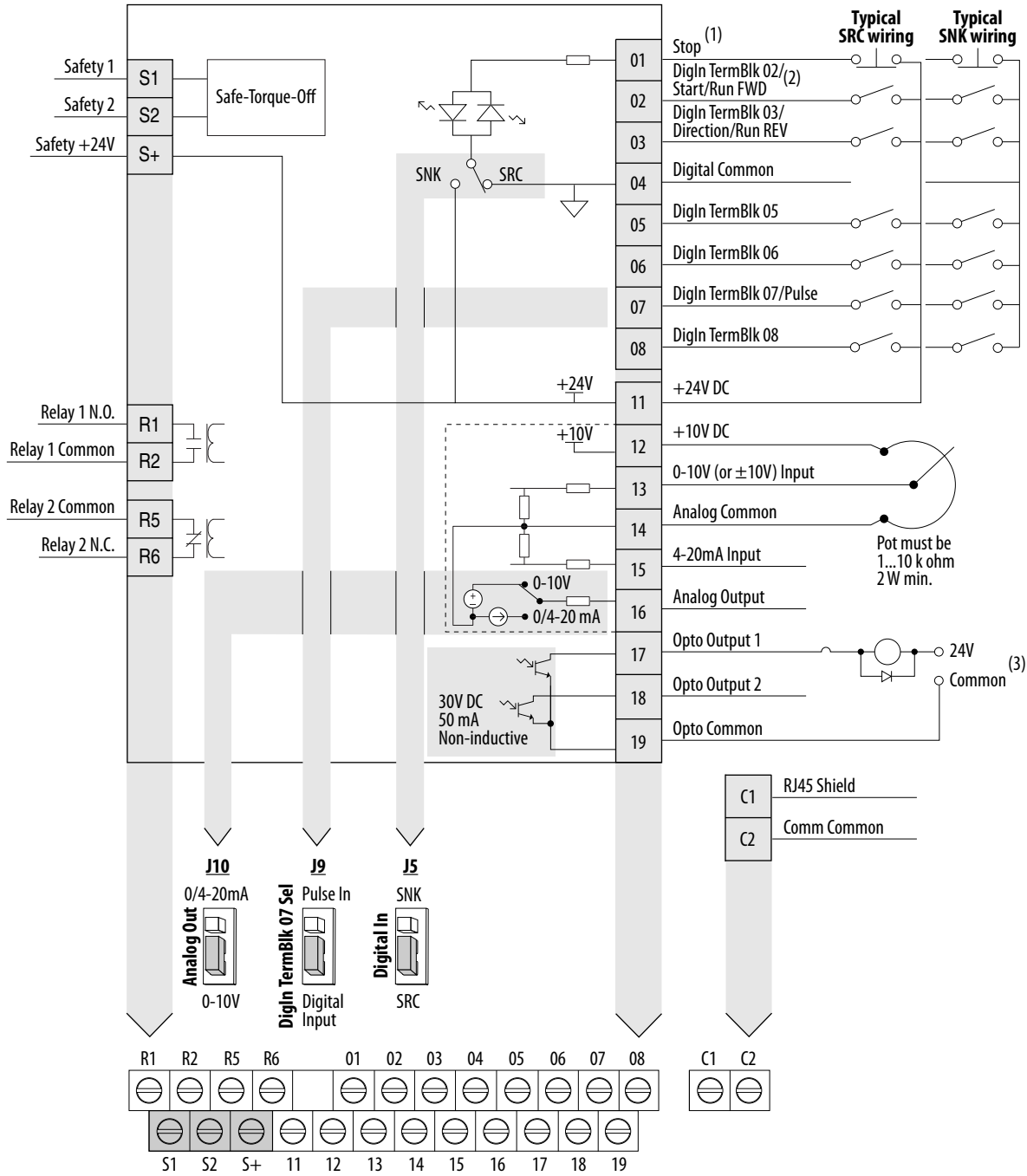

(1)

**IMPORTANT** I/O Terminal 01 is always a stop input. The stopping mode is determined by the drive setting. The drive is shipped with a jumper installed between I/O Terminals 01 and 11. Remove this jumper when using I/O Terminal 01 as a stop or enable input.

(2) Two wire control shown. For three wire control use a momentary input on I/O Terminal 02 to command a start. Use a maintained input for I/O Terminal 03 to change direction.  
 (3) Only one analog frequency source may be connected at a time. If more than one reference is connected at the same time, an undetermined frequency reference will result.

## PowerFlex 525 Control I/O Terminal Designations

No.	Signal	Default	Description	Parameter
R1	Relay 1 N.O.	Fault	Normally open contact for output relay.	t076
R2	Relay 1 Common	Fault	Common for output relay.	
R5	Relay 2 Common	Motor Running	Common for output relay.	t081
R6	Relay 2 N.C.	Motor Running	Normally closed contact for output relay.	
01	Stop	Coast	Three wire stop. However, it functions as a stop under all input modes and cannot be disabled.	P045
02	DigIn TermBlk 02/ Start/Run FWD	Run FWD	Used to initiate motion and also can be used as a programmable digital input. It can be programmed with t062 [DigIn TermBlk 02] as three wire (Start/Dir with Stop) or two wire (Run FWD/Run REV) control. Current consumption is 6 mA.	P045, P046, P048, P050, A544, t062
03	DigIn TermBlk 03/ Dir/Run REV	Run REV	Used to initiate motion and also can be used as a programmable digital input. It can be programmed with t062 [DigIn TermBlk 02] as three wire (Start/Dir with Stop) or two wire (Run FWD/Run REV) control. Current consumption is 6 mA.	t063
04	Digital Common	–	Return for digital I/O. Electrically isolated (along with the digital I/O) from the rest of the drive.	–
05	DigIn TermBlk 05	–Preset Freq	Program with t065 [DigIn TermBlk 05]. Current consumption is 6 mA.	t065
06	DigIn TermBlk 06	–Preset Freq	Program with t066 [DigIn TermBlk 06]. Current consumption is 6 mA.	t066
07	DigIn TermBlk 07/ Pulse In	Start Source 2 + Speed Reference2	Program with t067 [DigIn TermBlk 07]. Also functions as a Pulse Train input for reference or speed feedback. The maximum frequency is 100 kHz. Current consumption is 6 mA.	t067
08	DigIn TermBlk 08	Jog Forward	Program with t068 [DigIn TermBlk 08]. Current consumption is 6 mA.	t068
C1	C1	–	This terminal is tied to the RJ-45 port shield. Tie this terminal to a clean ground in order to improve noise immunity when using external communication peripherals.	–
C2	C2	–	This is the signal common for the communication signals.	–
S1	Safety 1	–	Safety input 1. Current consumption is 6 mA.	–
S2	Safety 2	–	Safety input 2. Current consumption is 6 mA.	–
S+	Safety +24V	–	+24V supply for safety circuit. Internally tied to the +24V DC source (Pin 11).	–
11	+24V DC	–	Referenced to Digital Common. Drive supplied power for digital inputs. Maximum output current is 100 mA.	–
12	+10V DC	–	Referenced to Analog Common. Drive supplied power for 0...10V external potentiometer. Maximum output current is 15 mA.	P047, P049
13	±10V In	Not Active	For external 0-10V (unipolar) or ±10V (bipolar) input supply or potentiometer wiper. Input impedance: Voltage source = 100 kW Allowable potentiometer resistance range = 1...10 kW	P047, P049, t062, t063, t065, t066, t093, A459, A471
14	Analog Common	–	Return for the analog I/O. Electrically isolated (along with the analog I/O) from the rest of the drive.	–
15	4-20mA In	Not Active	For external 4-20 mA input supply. Input impedance = 250 W	P047, P049, t062, t063, t065, t066, A459, A471
16	Analog Output	OutFreq 0-10	The default analog output is 0-10V. To convert a current value, change the Analog Output jumper to 0-20 mA. Program with t088 [Analog Out Sel]. Maximum analog value can be scaled with t089 [Analog Out High]. Maximum Load: 4-20 mA = 525 W (10.5V) 0-10V = 1 kW (10 mA)	t088, t089
17	Opto Output 1	Motor Running	Program with t069 [Opto Out1 Sel]. Each Opto-Output is rated 30V DC 50 mA (Non-inductive).	t069, t070, t075
18	Opto Output 2	At Frequency	Program with t072 [Opto Out1 Sel]. Each Opto-Output is rated 30V DC 50 mA (Non-inductive).	t072, t073, t075
19	Opto Common	–	The emitters of the Optocoupler Outputs (1 and 2) are tied together at Optocoupler Common. Electrically isolated from the rest of the drive.	–

## Prepare For Drive Start-Up



**ATTENTION:** Power must be applied to the drive to perform the following start-up procedures. Some of the voltages present are at incoming line potential. To avoid electric shock hazard or damage to equipment, only qualified service personnel should perform the following procedure. Thoroughly read and understand the procedure before beginning. If an event does not occur while performing this procedure, **Do Not Proceed. Remove All Power** including user supplied control voltages. User supplied voltages may exist even when main AC power is not applied to the drive. Correct the malfunction before continuing.

### Before Applying Power to the Drive

1. Disconnect and lock out power to the machine.
2. Verify that AC line power at the disconnect device is within the rated value of the drive.
3. If replacing a drive, verify the current drive's catalog number. Verify all options installed on the drive.
4. Verify that any digital control power is 24 volts.
5. Inspect grounding, wiring, connections, and environmental compatibility.
6. Verify that the Sink (SNK)/Source (SRC) jumper is set to match your control wiring scheme. See the [PowerFlex 523 Control I/O Wiring Block Diagram on page 11](#) and [PowerFlex 525 Control I/O Wiring Block Diagram on page 13](#) for location.

---

**IMPORTANT** The default control scheme is Source (SRC). The Stop terminal is jumpered to allow starting from the keypad or comms. If the control scheme is changed to Sink (SNK), the jumper must be removed from I/O Terminals 01 and 11 and installed between I/O Terminals 01 and 04.

---

7. Wire I/O as required for the application.
8. Wire the power input and output terminals.
9. Confirm that all inputs are connected to the correct terminals and are secure.
10. Collect and record motor nameplate and encoder or feedback device information. Verify motor connections.
  - Is the motor uncoupled?
  - What direction will the motor need to turn for the application?
11. Verify the input voltage to the drive. Verify if the drive is on a grounded system. Ensure the MOV jumpers are in the correct position. See [Ungrounded Distribution Systems on page 5](#) for more information on MOVs.
12. Apply power and reset the drive and communication adapters to factory default settings. To reset the drive, see parameter P053 [Reset to Defaults]. To reset the communication adapters, see the user manual of the adapter for more information.
13. Configure the basic program parameters related to the motor. See [Smart Start-Up with Basic Program Group Parameters on page 20](#) for more information.
14. Complete the autotune procedure for the drive. See parameter P040 [Autotune] for more information.
15. If you are replacing a drive and have a backup of the parameter settings obtained using the USB utility application, use the USB utility application to apply the backup to the new drive. See the PowerFlex 520-Series Adjustable Frequency AC Drive User Manual, publication [520-UM001](#) for more information on using the USB utility application.

Otherwise, set the necessary parameters for your application using the LCD keypad interface, Connected Components Workbench, or RSLogix or Logix Designer if using an Add-on Profile through EtherNet/IP.

- Configure the communication parameters needed for the application (node number, IP address, Datalinks in and out, communication rate, speed reference, start source, and so on). Record these settings for your reference.
- Configure the other drive parameters needed for the drive analog and digital I/O to work correctly. Verify the operation. Record these settings for your reference.

## Start, Stop, Direction, and Speed Control

Factory default parameter values allow the drive to be controlled from the keypad. No programming is required to start, stop, change direction, and control speed directly from the keypad.

**IMPORTANT** To disable reverse operation, see A544 [Reverse Disable].

See [Fault Codes on page 29](#) for an explanation of the fault codes.

## Display, Control, and Navigation Keys

**PowerFlex 523**

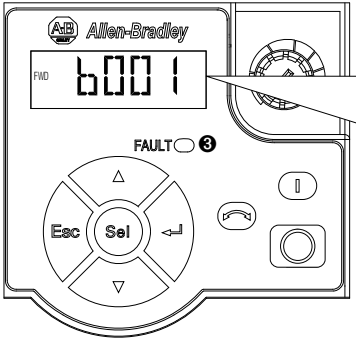

**PowerFlex 525**

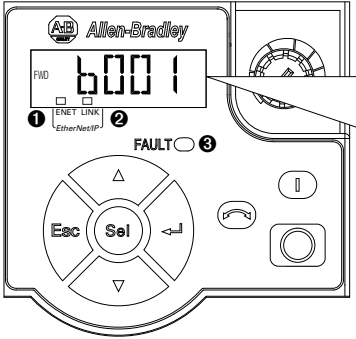









Menu	Parameter Group and Description
<b>b</b>	<b>Basic Display</b> Commonly viewed drive operating conditions.
<b>P</b>	<b>Basic Program</b> Commonly used programmable functions.
<b>t</b>	<b>Terminal Blocks</b> Programmable terminal functions.
<b>C</b>	<b>Communications</b> Programmable communication functions.
<b>L</b>	<b>Logic (PowerFlex 525 only)</b> Programmable logic functions.
<b>d</b>	<b>Advanced Display</b> Advanced drive operating conditions.
<b>R</b>	<b>Advanced Program</b> Remaining programmable functions.
<b>N</b>	<b>Network</b> Network functions that are shown only when a comm card is used.
<b>M</b>	<b>Modified</b> Functions from the other groups with values changed from default.
<b>f</b>	<b>Fault and Diagnostic</b> Consists of list of codes for specific fault conditions.
<b>G</b>	<b>AppView and CustomView</b> Functions from the other groups organized for specific applications.

**PowerFlex 525 Embedded EtherNet/IP Indicators**

No.	Display	Display State	Description
①	ENET	Off	Adapter is not connected to the network.
		Steady	Adapter is connected to the network and drive is controlled through Ethernet.
		Flashing	Adapter is connected to the network but drive is not controlled through Ethernet.
②	LINK	Off	Adapter is not connected to the network.
		Steady	Adapter is connected to the network but not transmitting data.
		Flashing	Adapter is connected to the network and transmitting data.



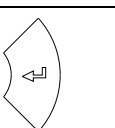









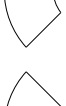









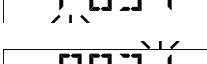

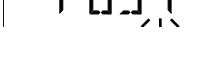

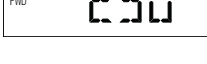

No.	LED	LED State	Description
③	FAULT	Flashing Red	Indicates drive is faulted.

Key	Name	Description	Key	Name	Description
	Up Arrow	Scroll through user-selectable display parameters or groups. Increment values.		Reverse	Used to reverse direction of the drive. Default is active. Controlled by parameters P046, P048, and P050 [Start Source x] and A544 [Reverse Disable].
	Down Arrow				
	Escape	Back one step in programming menu. Cancel a change to a parameter value and exit Program Mode.		Start	Used to start the drive. Default is active. Controlled by parameters P046, P048, and P050 [Start Source x].
	Select	Advance one step in programming menu. Select a digit when viewing parameter value.		Stop	Used to stop the drive or clear a fault. This key is always active. Controlled by parameter P045 [Stop Mode].
	Enter	Advance one step in programming menu. Save a change to a parameter value.		Potentiometer	Used to control speed of drive. Default is active. Controlled by parameters P047, P049, and P051 [Speed Referencex].

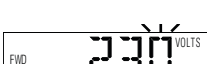

## Viewing and Editing Parameters

The following is an example of basic keypad and display functions. This example provides basic navigation instructions and illustrates how to program a parameter.

Step	Key	Example Display
1 When power is applied, the last user-selected Basic Display Group parameter number is briefly displayed with flashing characters. The display then defaults to that parameter's current value. (Example shows the value of b001 [Output Freq] with the drive stopped.)	-	
2 Press Esc to display the Basic Display Group parameter number shown on power-up. The parameter number will flash.		
3 Press Esc to enter the parameter group list. The parameter group letter will flash.		
4 Press the Up Arrow or Down Arrow to scroll through the group list (b, P, t, C, L, d, A, f and Gx).	 or 	
5 Press Enter or Sel to enter a group. The right digit of the last viewed parameter in that group will flash.	 or 	
6 Press the Up Arrow or Down Arrow to scroll through the parameter list.	 or 	
7 Press Enter to view the value of the parameter. Or Press Esc to return to the parameter list.		
8 Press Enter or Sel to enter Program Mode and edit the value. The right digit will flash and the word Program on the LCD display will light up.	 or 	
9 Press the Up Arrow or Down Arrow to change the parameter value.	 or 	
10 If desired, press Sel to move from digit to digit or bit to bit. The digit or bit that you can change will flash.		
11 Press Esc to cancel a change and exit Program Mode. Or Press Enter to save a change and exit Program Mode. The digit will stop flashing and the word Program on the LCD display will turn off.	 or 	
12 Press Esc to return to the parameter list. Continue to press Esc to back out of the programming menu. If pressing Esc does not change the display, then b001 [Output Freq] is displayed. Press Enter or Sel to enter the group list again.		

## Basic Display Group Parameters

See the PowerFlex 520-Series Adjustable Frequency AC Drive User Manual, publication [520-UM001](#) for detailed descriptions of the parameters listed here, as well as the full list of available parameters.

No.	Parameter	Min/Max	Display/Options
b001	[Output Freq]	0.00/[Maximum Freq]	0.01 Hz
	Output frequency present at T1, T2 & T3 (U, V & W). Does not include slip frequency.		
b002	[Commanded Freq]	0.00/[Maximum Freq]	0.01 Hz
	Value of the active frequency command even if the drive is not running. <b>Important:</b> The frequency command can come from a number of sources.		
b003	[Output Current]	0.00/(Drive Rated Amps x 2)	0.01 A
	Output current present at T1, T2 & T3 (U, V & W).		
b004	[Output Voltage]	0.0/Drive Rated Volts	0.1V
	Output voltage present at T1, T2 & T3 (U, V & W).		
b005	[DC Bus Voltage]	0/1200VDC	1VDC
	Filtered DC bus voltage level of the drive.		
b006	[Drive Status]	00000/11111	<u>Digit 5</u> <u>Digit 4</u> <u>Digit 3</u> <u>Digit 2</u> <u>Digit 1</u> SafetyActive <sup>(1)</sup> Decelerating    Accelerating    Forward    Running
	Present operating condition of the drive. (1) Setting is specific to PowerFlex 525 drives only.		
b007, b008, b009	[Fault x Code]	F0/F127	F0
A code that represents a drive fault. Codes appear in these parameters in the order they occur (b007 [Fault 1 Code] = the most recent fault). Repetitive faults are only recorded once. See Fault and Diagnostic Group for more information.			
b010	[Process Display]	0/9999	1
	Output frequency scaled by [Process Disp Hi] and [Process Disp Lo].		
b0012	[Control Source]	0000/2165	<u>Digit 4, 3, &amp; 2</u> <u>Digit 1</u> Freq Command Source            Start Command Source
	Active source of the Start Command and Frequency Command. Normally defined by the settings of P046, P048, P050 [Start Source x] and P047, P049, P051 [Speed Referencex].		
b013	[Contrl In Status]	0000/1111	<u>Digit 4</u> <u>Digit 3</u> <u>Digit 2</u> <u>Digit 1</u> DB Trans On <sup>(1)</sup> DigIn TBlk 3    DigIn TBlk 2    DigIn TBlk 1
	State of the digital terminal blocks 1...3 and DB transistor. <b>Important:</b> Actual control commands may come from a source other than the control terminal block. (1) Setting is specific to PowerFlex 525 drives only.		
b014	[Dig In Status]	0000/1111	<u>Digit 4</u> <u>Digit 3</u> <u>Digit 2</u> <u>Digit 1</u> DigIn TBlk 8 <sup>(1)</sup> DigIn TBlk 7 <sup>(1)</sup> DigIn TBlk 6    DigIn TBlk 5
	State of the programmable digital inputs. (1) Setting is specific to PowerFlex 525 drives only.		
b015	[Output RPM]	0/24000 rpm	1 rpm
	Current output frequency in rpm. Scale is based on P035 [Motor NP Poles].		
b016	[Output Speed]	0.0/100.0%	0.1%
	Current output frequency in %. Scale is 0% at 0.00 Hz to 100% at P044 [Maximum Freq].		
b017	[Output Power]	0.00/(Drive Rated Power x 2)	0.01 kW
	Output power present at T1, T2 & T3 (U, V & W).		
b018	[Power Saved]	0.00/655.35 kW	0.01 kW
	Instantaneous power savings of using this drive compared to an across the line starter.		
b019	[Elapsed Run time]	0/65535 x 10 hr	1 = 10 hr
	Accumulated time drive is outputting power. Time is displayed in 10 hour increments.		
b020	[Average Power]	0.00/(Drive Rated Power x 2)	0.01 kW
	Average power used by the motor since the last reset of the meters.		
b021	[Elapsed kWh]	0.0/100.0 kWh	0.1 kWh
	Accumulated output energy of the drive. When the maximum value of this parameter is reached, it resets to zero and b022 [Elapsed MWh] is incremented.		

No.	Parameter	Min/Max	Display/Options
b022	[Elapsed MWh]	0.0/6553.5 MWh	0.1 MWh
	Accumulated output energy of the drive.		
b023	[Energy Saved]	0.0/6553.5 kWh	0.1 kWh
	Total energy savings of using this drive compared to an across the line starter since the last reset of the meters.		
b024	[Accum kWh Sav]	0.0/6553.5 kWh	0.1 = 10 kWh
	Total approximate accumulated energy savings of the drive compared to using an across the line starter.		
b025	[Accum Cost Sav]	0.0/6553.5	0.1
	Total approximate accumulated cost savings of the drive compared to using an across the line starter. [Accum Cost Sav] = [Average kWh cost] x [Accum kWh Sav]		
b026	[Accum CO2 Sav]	0.0/6553.5 kg	0.1 kg
	Total approximate accumulated CO2 savings of the drive compared to using an across the line starter.		
b027	[Drive Temp]	0/120 °C	1 °C
	Present operating temperature of the drive heatsink (inside module).		
b028	[Control Temp]	0/120 °C	1 °C
	Present operating temperature of the drive control.		
b029	[Control SW Ver]	0.000/65.535	0.001
	Current drive firmware version.		

## Smart Start-Up with Basic Program Group Parameters

The PowerFlex 520-series drive is designed so that start-up is simple and efficient. The Basic Program group contains the most commonly used parameters. See the PowerFlex 520-Series Adjustable Frequency AC Drive User Manual, publication [520-UM001](#) for detailed descriptions of the parameters listed here, as well as the full list of available parameters.





= Stop drive before changing this parameter.







= Parameter is specific to PowerFlex 525 drives only.

No.	Parameter	Min/Max	Display/Options	Default
P030	[Language] Selects the language displayed. <b>Important:</b> The setting takes effect after the drive is power cycled.	1/15	1 = English 2 = Français 3 = Español 4 = Italiano 5 = Deutsch 6 = Reserved 7 = Português 8 = Reserved 9 = Reserved 10 = Reserved 11 = Reserved 12 = Polish 13 = Reserved 14 = Turkish 15 = Czech	1
P031	[Motor NP Volts] Sets the motor nameplate rated volts.	10V (for 200V Drives), 20V (for 400V Drives), 25V (for 600V Drives) / Drive Rated Volts	1V	Based on Drive Rating
P032	[Motor NP Hertz] Sets the motor nameplate rated frequency.	15/500 Hz	0.1 A	60 Hz
P033	[Motor OL Current] Sets the motor nameplate overload current.	0.0/(Drive Rated Amps x 2)	0.1 A	Based on Drive Rating
P034	[Motor NP FLA] Sets the motor nameplate FLA.	0.0/(Drive Rated Amps x 2)	0.1 A	Drive Rated Amps
P035	[Motor NP Poles] Sets the number of poles in the motor.	2/40	1	4
P036	[Motor NP RPM] Sets the rated nameplate rpm of motor.	0/24000 rpm	1 rpm	1750 rpm
P037	[Motor NP Power] Sets the motor nameplate power. Used in PM regulator.	0.00/Drive Rated Power	0.01 kW	Drive Rated Power
P038	[Voltage Class] Sets the voltage class of 600V drives. Only applicable to 600V drives.	2/3	2 = "480V" 3 = "600V"	3
P039	[Torque Perf Mode] Selects the motor control mode. (1) Setting is specific to PowerFlex 525 drives only.	0/3	0 = "V/Hz" 1 = "SVC" 2 = "Economize" 3 = "Vector" <sup>(1)</sup>	1
P040	[Autotune] Enables a static (not spinning) or dynamic (motor spinning) autotune.	0/2	0 = "Ready/Idle" 1 = "Static Tune" 2 = "Rotate Tune"	0
P041	[Accel Time 1] Sets the time for the drive to accel from 0 Hz to [Maximum Freq].	0.00/600.00 s	0.01 s	10.00 s
P042	[Decel Time 1] Sets the time for the drive to decel from [Maximum Freq] to 0 Hz.	0.00/600.00 s	0.01 s	10.00 s

 = Stop drive before changing this parameter.

 = Parameter is specific to PowerFlex 525 drives only.



No.	Parameter	Min/Max	Display/Options	Default
P043	[Minimum Freq]	0.00/500.00 Hz	0.01 Hz	0.00 Hz
	Sets the lowest frequency the drive outputs.			
P044	[Maximum Freq]	0.00/500.00 Hz	0.01 Hz	60.00 Hz
	Sets the highest frequency the drive outputs.			
P045	[Stop Mode]	0/11	0 = "Ramp, CF" <sup>(1)</sup> 1 = "Coast, CF" <sup>(1)</sup> 2 = "DC Brake, CF" <sup>(1)</sup> 3 = "DCBrkAuto, CF" <sup>(1)</sup> 4 = "Ramp" 5 = "Coast" 6 = "DC Brake" 7 = "DC BrakeAuto" 8 = "Ramp+EM B, CF" <sup>(1)</sup> 9 = "Ramp+EM Brk" 10 = "PointStp, CF" <sup>(1)</sup> 11 = "PointStop"	0
	Stop command for normal stop. <b>Important:</b> I/O Terminal 01 is always a stop input. The stopping mode is determined by the drive setting. <b>Important:</b> The drive is shipped with a jumper installed between I/O Terminals 01 and 11. Remove this jumper when using I/O Terminal 01 as a stop or enable input. (1) Stop input also clears active fault.			
P046, P048, P050	[Start Source x]	1/5	1 = "Keypad" <sup>(1)</sup> 2 = "DigIn TrmBlk" <sup>(2)</sup> 3 = "Serial/DSI" 4 = "Network Opt" 5 = "Ethernet/IP" <sup>(3)</sup>	P046 = 1 P048 = 2 P050 = 3 (PowerFlex 523) 5 (PowerFlex 525)
	Sets the default control scheme used to start the drive unless overridden by P048 [Start Source 2] or P050 [Start Source 3]. (1) When active, the Reverse key is also active unless disabled by A544 [Reverse Disable]. (2) If "DigIn TrmBlk" is selected, ensure that the digital inputs are properly configured. (3) Setting is specific to PowerFlex 525 drives only.			
P047, P049, P051	[Speed Referencex]	1/16	1 = "Drive Pot" 2 = "Keypad Freq" 3 = "Serial/DSI" 4 = "Network Opt" 5 = "0-10V Input" 6 = "4-20mA Input" 7 = "Preset Freq" 8 = "Anlg In Mult" <sup>(1)</sup> 9 = "MOP" 10 = "Pulse Input" 11 = "PID1 Output" 12 = "PID2 Output" <sup>(1)</sup> 13 = "Step Logic" <sup>(1)</sup> 14 = "Encoder" <sup>(1)</sup> 15 = "Ethernet/IP" <sup>(1)</sup> 16 = "Positioning" <sup>(1)</sup>	P047 = 1 P049 = 5 P051 = 3 (PowerFlex 523) 15 (PowerFlex 525)
	Sets the default speed command of the drive unless overridden by P049 [Speed Reference2] or P051 [Speed Reference3]. (1) Setting is specific to PowerFlex 525 drives only.			
P052	[Average kWh Cost]	0.00/655.35	0.01	0.00
	Sets the average cost per kWh.			
P053	[Reset To Defaults]	0/3	0 = "Ready/Idle" 1 = "Param Reset" 2 = "Factory Rset" 3 = "Power Reset"	0
	Resets parameters to their factory defaults values. After a Reset command, the value of this parameter returns to zero.			

## Advanced Program Group Parameters

See the PowerFlex 520-Series Adjustable Frequency AC Drive User Manual, publication [520-UM001](#) for detailed descriptions of the parameters listed here, as well as the full list of available parameters.

 = Stop drive before changing this parameter.

 = Parameter is specific to PowerFlex 525 drives only.

No.	Parameter	Min/Max	Display/Options	Default
A410...	[Preset Freq x]	0.00/500.00 Hz	0.01 Hz	Preset Freq 0 = 0.00 Hz
A417	Sets the frequency of the drive outputs to the programmed value when selected.			Preset Freq 1 = 5.00 Hz
A418...				Preset Freq 2 = 10.00 Hz
A425				Preset Freq 3 = 20.00 Hz
				Preset Freq 4 = 30.00 Hz
				Preset Freq 5 = 40.00 Hz
				Preset Freq 6 = 50.00 Hz
				Preset Freq 7...15 = 60.00 Hz
A426	[Keypad Freq]	0.00/500.00 Hz	0.01 Hz	60.00 Hz
	Provides the drive frequency command using the built-in keypad navigation. When P047, P049 or P051 [Speed Referencex] selects 2 "Keypad Freq", the value set in this parameter controls the frequency of the drive. The value of this parameter can also be changed when navigating with the keypad by pressing the Up or Down arrow keys.			
A427	[MOP Freq]	0.00/500.00 Hz	0.01 Hz	60.00 Hz
	Provides the drive frequency command using the built-in Motor Operated Potentiometer (MOP). <b>Important:</b> Frequency is not written to non-volatile storage until drive is powered-down. If both MOP Up and MOP Down are applied at the same time, the inputs are ignored and the frequency is unchanged.			
A428	[MOP Reset Sel]	0/1	0 = "Zero MOP Ref" 1 = "Save MOP Ref"	1 = "Save MOP Ref"
	Determines if the current MOP reference command is saved on power down.			
A429	[MOP Preload]	0/1	0 = "No preload" 1 = "Preload"	0 = "No preload"
	Determines the operation of the MOP function.			
A430	[MOP Time]	0.1/600.0 s	0.1 s	10.0 s
	Sets the rate of change of the MOP reference.			
A431	[Jog Frequency]	0.00/[Maximum Freq]	0.01 Hz	10.00 Hz
	Sets the output frequency when a jog command is issued.			
A432	[Jog Accel/Decel]	0.01/600.00 s	0.01 s	10.00 s
	Sets the acceleration and deceleration time used when in jog mode.			
A433	[Purge Frequency]	0.00/500.00 Hz	0.01 Hz	5.00 Hz
	Provides a fixed frequency command value when t062, t063, t065-t068 [DigIn TermBlk xx] is set to 40 "Purge".			
A434	[DC Brake Time]	0.0/99.9 s	0.1 s	0.0 s
	Sets the length of time that DC brake current is "injected" into the motor.			
A435	[DC Brake Level]	0.00/(Drive Rated Amps x 1.80)	0.01 A	Drive Rated Amps x 0.05
	Defines the maximum DC brake current, in amps, applied to the motor when P045 [Stop Mode] is set to either 4 "Ramp" or 6 "DC Brake". <b>ATTENTION:</b> If a hazard of injury due to movement of equipment or material exists, an auxiliary mechanical braking device must be used. This feature should not be used with synchronous motors. Motors may be demagnetized during braking.			
A436	[DC Brk Time@Strt]	0.0/99.9 s	0.1 s	0.0 s
	Sets the length of time that DC brake current is "injected" into the motor after a valid start command is received.			
A437	[DB Resistor Sel]	0/99	0 = "Disabled" 1 = "Norml RA Res" 2 = "NoProtection" 3...99 = "3...99% DutyCycle"	0 = "Disabled"
	Enables/disables external dynamic braking and selects the level of resistor protection.			













 = Stop drive before changing this parameter.

 (PF 525) = Parameter is specific to PowerFlex 525 drives only.

No.	Parameter	Min/Max	Display/Options	Default
A438	[DB Threshold] Sets the DC bus voltage threshold for Dynamic Brake operation. If DC bus voltage rises above this level, Dynamic Brake turns on. Lower values makes the dynamic braking function more responsive but may result in nuisance Dynamic Brake activation. <b>ATTENTION:</b> Equipment damage may result if this parameter is set to a value that causes the dynamic braking resistor to dissipate excessive power. Parameter settings less than 100% should be carefully evaluated to ensure that the Dynamic Brake resistor's wattage rating is not exceeded. In general, values less than 90% are not needed. This parameter's setting is especially important if parameter A437 [DB Resistor Sel] is set to 2 "NoProtection".	10.0/110.0%	0.1%	100.0%
A439	[S Curve %] Enables a fixed shape S-Curve that is applied to the acceleration and deceleration ramps (including jog). S-Curve Time = (Accel or Decel Time) x (S-Curve Setting in percentage)	0/100%	1%	0%
A440	[PWM Frequency] Sets the carrier frequency for the PWM output waveform. The chart below provides derating guidelines based on the PWM frequency setting. <b>Important:</b> Ignoring derating guidelines can cause reduced drive performance. The drive may automatically reduce the PWM carrier frequency at low output speeds, unless prevented from doing so by A540 [Var PWM Disable].	2.0/16.0 kHz	0.1 kHz	4.0 kHz
A441 (PF 525)	[Droop Hertz@ FLA] Reduces the frequency based on current. This frequency is subtracted from the commanded output frequency. Generally Slip and Droop would not both be used, but if both are enabled they simply subtract from each other. Typically used in load sharing schemes.	0.0/10.0 Hz	0.1 Hz	0.0 Hz
A442, A444, A446	[Accel Time x] Time for the drive to ramp from 0.0 Hz to P044 [Maximum Freq] if Accel Time x is selected. Accel Rate = [Maximum Freq] / [Accel Time]	0.01 s	0.00/600.00 s	10.00 s
A443, A445, A447	[Decel Time x] Time for the drive to ramp from P044 [Maximum Freq] to 0.0 Hz if Decel Time x is selected. Decel Rate = [Maximum Freq] / [Decel Time]	0.00/600.00 s	0.01 s	10.00 s
A448, A450  A452, A454 (PF 525)	[Skip Frequency x] Works in conjunction with A449, A451, A453 and A455 [Skip Freq Band x] creating a range of frequencies at which the drive does not operate continuously	0.0/500.0 Hz	0.1 Hz	0.0 Hz (Disabled)
A449, A451  A453, A455 (PF 525)	[Skip Freq Band x] Determines the band around A448, A450, A452 and A454 [Skip Frequency x].	0.0/30.0 Hz	0.1 Hz	0.0 Hz
A456  A468 (PF 525)	[PID x Trim Hi] Scales the upper value of the trim frequency when trim is active.	0.0/500.0 Hz	0.1 Hz	60.0 Hz
A457  A469 (PF 525)	[PID x Trim Lo] Scales the lower value of the trim frequency when trim is active.	0.0/500.0 Hz	0.1 Hz	0.0 Hz

 = Stop drive before changing this parameter.

 = Parameter is specific to PowerFlex 525 drives only.

No.	Parameter	Min/Max	Display/Options	Default
A458   A470  	[PID x Trim Sel]  Sets the PID output as trim to the source reference. (1) Setting is specific to PowerFlex 525 drives only.	0/13	0 = "Disabled" 1 = "TrimOn Pot" 2 = "TrimOn Keypd" 3 = "TrimOn DSI" 4 = "TrimOn NetOp" 5 = "TrimOn 0-10V" 6 = "TrimOn 4-20" 7 = "TrimOn Prset" 8 = "TrimOn AnMlt" <sup>(1)</sup> 9 = "TrimOn MOP" 10 = "TrimOn Pulse" 11 = "TrimOn Slgic" <sup>(1)</sup> 12 = "TrimOn Encdr" <sup>(1)</sup> 13 = "TrimOn ENet" <sup>(1)</sup>	0 = "Disabled"
A459   A471  	[PID x Ref Sel]  Selects the source of the PID reference. (1) Setting is specific to PowerFlex 525 drives only.	0/13	0 = "PID Setpoint" 1 = "Drive Pot" 2 = "Keypad Freq" 3 = "Serial/DSI" 4 = "Network Opt" 5 = "0-10V Input" 6 = "4-20mA Input" 7 = "Preset Freq" 8 = "AnIIn Multi" <sup>(1)</sup> 9 = "MOP Freq" 10 = "Pulse Input" 11 = "Step Logic" <sup>(1)</sup> 12 = "Encoder" <sup>(1)</sup> 13 = "EtherNet/IP" <sup>(1)</sup>	0 = "PID Setpoint"
A460  A472 	[PID x Fdback Sel]  Selects the source of the PID feedback. (1) Setting is specific to PowerFlex 525 drives only.	0/6	0 = "0-10V Input" 1 = "4-20mA Input" 2 = "Serial/DSI" 3 = "Network Opt" 4 = "Pulse Input" 5 = "Encoder" <sup>(1)</sup> 6 = "EtherNet/IP" <sup>(1)</sup>	0 = "0-10V Input"
A461  A473 	[PID x Prop Gain]  Sets the value for the PID proportional component when the PID mode is enabled.	0.00/99.99	0.01	0.01
A462  A474 	[PID x Integ Time]  Sets the value for the PID integral component when PID mode is enabled.	0.0/999.9 s	0.1 s	2.0 s
A463  A475 	[PID x Diff Rate]  Sets the value (in 1/second) for the PID differential component when PID mode is enabled.	0.00/99.99	0.01	0.00
A464  A476 	[PID x Setpoint]  Provides an internal fixed value for process setpoint when PID mode is enabled.	0.0/100.0%	0.1%	0.0%
A465  A477 	[PID x Deadband]  Sets the lower limit of the PID output.	0.0/10.0%	0.1%	0.0%



 = Stop drive before changing this parameter.

 (PF 525) = Parameter is specific to PowerFlex 525 drives only.

No.	Parameter	Min/Max	Display/Options	Default
A466	[PID x Preload]	0.0/500.0 Hz	0.1 Hz	0.0 Hz
A478 (PF 525)	Sets the value used to preload the integral component on start or enable.			
A467	[PID x Invert Err]	0/1	0 = "Normal" 1 = "Inverted"	0 = "Normal"
A479 (PF 525)	Changes the sign of the PID error.			
A481	[Process Disp Lo]	0.00/99.99	0.01	0.00
	Sets the value displayed in b010 [Process Display] when the drive is running at P043 [Minimum Freq].			
A482	[Process Disp Hi]	0.00/99.99	0.01	0.00
	Sets the value displayed in b010 [Process Display] when the drive is running at P044 [Maximum Freq].			
A483	[Testpoint Sel]	0/FFFF	1	400
	Used by Rockwell Automation field service personnel.			
A484	[Current Limit 1]	0.0/Drive Rated Amps x 1.5 (Normal Duty); Drive Rated Amps x 1.8 (Heavy Duty)	0.1 A	Drive Rated Amps x 1.1 (Normal Duty); Drive Rated Amps x 1.5 (Heavy Duty)
	Maximum output current allowed before current limiting occurs.			
A485 (PF 525)	[Current Limit 2]	0.0/Drive Rated Amps x 1.5 (Normal Duty); Drive Rated Amps x 1.8 (Heavy Duty)	0.1 A	Drive Rated Amps x 1.1
	Maximum output current allowed before current limiting occurs.			
A486	[Shear Pinx Level]	0.0/(Drive Rated Amps x 2)	0.1 A	0.0 A (Disabled)
A488 (PF 525)	Sets the value of current at which the shear pin fault occurs after the time set in A487, A489 [Shear Pin x Time]. Setting the value at 0.0 A disables this function.			
A487	[Shear Pin x Time]	0.00/30.00 s	0.01 s	0.00 s
A489 (PF 525)	Sets the continuous time the drive must be at or above the value set in A486, A488 [Shear Pinx Level] before a shear pin fault occurs.			
A490 (PF 525)	[Load Loss Level]	0.0/Drive Rated Amps	0.1 A	0.0 A
	Provides a software trip (Load Loss fault) when the current drops below this level for the time specified in A491 [Load Loss Time].			
A491 (PF 525)	[Load Loss Time]	0/9999 s	1 s	0 s
	Sets the required time for the current to be below A490 [Load Loss Level] before a Load Loss fault occurs			
A492	[Stall Fault Time]	0/5	0 = "60 Seconds" 1 = "120 Seconds" 2 = "240 Seconds" 3 = "360 Seconds" 4 = "480 Seconds" 5 = "Flt Disabled"	0 = "60 Seconds"
	Sets the time that the drive remains in stall mode before a fault is issued.			
A493	[Motor OL Select]	0/2	0 = "No Derate" 1 = "Min. Derate" 2 = "Max. Derate"	0 = "No Derate"
	Drive provides Class 10 overload protection. Settings 0...2 select the derating factor for the I <sup>2</sup> t overload function.			
A494	[Motor OL Ret]	0/1	0 = "Reset" 1 = "Save"	0 = "Reset"
	Selects whether the motor overload counter is saved on power-down or reset on power-up.			
A495	[Drive OL Mode]	0/3	0 = "Disabled" 1 = "Reduce CLim" 2 = "Reduce PWM" 3 = "Both-PWM 1st"	3 = "Both-PWM 1st"
	Determines how the drive handles overload conditions that would otherwise cause the drive to fault.			
A496	[IR Voltage Drop]	0.0/600.0VAC	0.1VAC	Based on Drive Rating
	Value of volts dropped across the resistance of the motor stator (autotune) for induction motor.			
A497	[Flux Current Ref]	0.00/(Drive Rated Amps x 1.4)	0.01 A	Based on Drive Rating
	This is the current necessary for full motor flux. The value should be set to the full speed no-load current of the motor.			





 = Stop drive before changing this parameter.

 (PF 525) = Parameter is specific to PowerFlex 525 drives only.

No.	Parameter	Min/Max	Display/Options	Default
A498 (PF 525)	[Motor Rr] Rotor resistance of induction motor.	0.00/655.35 ohm	0.01 ohm	Based on Drive Rating
A499 (PF 525)	[Motor Lm] Mutual Inductance of induction motor.	0.0/6553.5 mH	0.1 mH	Based on Drive Rating
A500 (PF 525)	[Motor Lx] Leakage Inductance of induction motor.	0.0/6553.5 mH	0.1 mH	Based on Drive Rating
A509 (PF 525)	[Speed Reg Sel] Determines if PI gain of the "Vector" control mode speed regulator is set automatically or manually. Parameters A521...A526 are set automatically by this parameter.	0/1	0 = "Automatic" 1 = "Manual"	0 = "Automatic"
A510, A512, A514 (PF 525)	[Freq x] Sets the "Vector" control mode frequency.	0.00/200.00%	0.01%	Freq 1 = 8.33% Freq 2 = 15.00% Freq 3 = 20.00%
A511, A513, A515 (PF 525)	[Freq x BW] Speed control loop bandwidth for "Vector" control mode.	0/40 Hz	1 Hz	10 Hz
A521, A523, A525 (PF 525)	[Freq x Kp] Sets P-gain of "Vector" control mode when in frequency region 1, 2 or 3 for faster speed response during dynamic-state where motor is still accelerating. If A509 [Speed Reg Sel] is set to 1 "Manual", these parameters can be changed.	0.0/500.0%	0.1%	100.0%
A522, A524, A526 (PF 525)	[Freq x Ki] Sets I-gain of "Vector" control mode when in frequency region 1, 2 or 3 for faster speed response during steady-state where motor is at its rated speed. If A509 [Speed Reg Sel] is set to 1 "Manual", these parameters can be changed.	0.000/10.000 s	0.001 s	0.100 s
A530	[Boost Select] Sets the boost voltage (% of P031 [Motor NP Volts]) and redefines the V/Hz curve. Only used for V/Hz and SVC control modes.	0/14	0 = "Custom V/Hz" 1 = "30.0, VT" 2 = "35.0, VT" 3 = "40.0, VT" 4 = "45.0, VT" 5 = "0.0, no IR" 6 = "0.0" 7 = "2.5, CT" 8 = "5.0, CT" 9 = "7.5, CT" 10 = "10.0, CT" 11 = "12.5, CT" 12 = "15.0, CT" 13 = "17.5, CT" 14 = "20.0, CT"	6 = "0.0" (For 400V and 600V drives, 5 HP and above) 7 = "2.5, CT" (For 200V drives, 5 HP and above) 8 = "5.0, CT" (For drives below 5 HP)
A531	[Start Boost] Sets the boost voltage (% of P031 [Motor NP Volts]) and redefines the V/Hz curve when A530 [Boost Select] = 0 "Custom V/Hz" and P039 [Torque Perf Mode] = 0 "V/Hz".	0.0/25.0%	0.1%	2.5%
A532	[Break Voltage] Sets the voltage (in percent of [Base Frequency]) at the A533 [Break Frequency] if A530 [Boost Select] is set to 0 "Custom V/Hz".	0.0/100.0%	0.1%	25.0%
A533	[Break Frequency] Sets the frequency where A532 [Break Voltage] is applied if A530 [Boost Select] is set to 0 "Custom V/Hz".	0.0/500.0 Hz	0.1 Hz	15.0 Hz
A534	[Maximum Voltage] Sets the highest voltage the drive outputs.	Min = 10V AC (on 230V AC Drives); 20V AC (on 460V AC Drives); 25V AC (on 600V AC Drives) Max = 255V AC (on 230V AC Drives); 510V AC (on 460V AC Drives); 637.5V AC (on 600V AC Drives)	1V AC	Drive Rated Volts



 = Stop drive before changing this parameter.

 (PF 525) = Parameter is specific to PowerFlex 525 drives only.

No.	Parameter	Min/Max	Display/Options	Default
A535  (PF 525)	[Motor Fdbk Type] Selects the encoder type. <b>ATTENTION:</b> The loss of analog input, encoder or other feedback may cause unintended speed or motion. Take appropriate precautions to guard against possible unintended speed or motion.	0/5	0 = "None" 1 = "Pulse Train" 2 = "Single Chan" 3 = "Single Check" 4 = "Quadrature" 5 = "Quad Check"	0 = "None"
A536 (PF 525)	[Encoder PPR] Specifies the encoder Pulses Per Revolution (PPR) when an encoder is used.	1/20000 PPR	1 PPR	1024 PPR
A537	[Pulse In Scale] Sets the scale factor/gain for the Pulse Input when t065 or t067 [DigIn TermBlk xx] is set to 52 "Pulse Train", or A535 [Motor Fdbk Type] is set to 1 "Pulse Train". Input frequency (Hz) / Pulse in Scale = Output frequency (Hz)	0/20000	1	64
A538 (PF 525)	[Ki Speed Loop] Sets the I-gain used in the PI calculation of the speed loop when feedback is used.	0.0/400.0	0.1	2.0
A539 (PF 525)	[Kp Speed Loop] Sets the P-gain used in the PI calculation of the speed loop when feedback is used.	0.0/200.0	0.1	5.0
A540 	[Var PWM Disable] Enables/disables a feature that varies the carrier frequency for the PWM output waveform defined by A440 [PWM Frequency].	0/1	0 = "Enabled" 1 = "Disabled"	0 = "Enabled"
A541	[Auto Rstrt Tries] Sets the maximum number of times the drive attempts to reset a fault and restart. <b>ATTENTION:</b> Equipment damage and/or personal injury may result if this parameter is used in an inappropriate application. Do not use this function without considering applicable local, national and international codes, standards, regulations or industry guidelines.	0/9	1	0
A542	[Auto Rstrt Delay] Sets the time between restart attempts if A541 [Auto Rstrt Tries] is not zero.	0.0/120.0 s	0.1 s	1.0 s
A543 	[Start At PowerUp] Enables/disables drive start on power up without a Start command being cycled. Requires a digital input configured for Run or Start and a valid start contact. <b>ATTENTION:</b> Equipment damage and/or personal injury may result if this parameter is used in an inappropriate application. Do not use this function without considering applicable local, national and international codes, standards, regulations or industry guidelines.	0/1	0 = "Enabled" 1 = "Disabled"	0 = "Disabled"
A544 	[Reverse Disable] Enables/disables the function that allows the direction of motor rotation to be changed.	0/1	0 = "Rev Enabled" 1 = "Rev Disabled"	0 = "Rev Enabled"
A545	[Flying Start En] Sets the condition that allows the drive to reconnect to a spinning motor at actual RPM.	0/1	0 = "Enabled" 1 = "Disabled"	0 = "Disabled"
A546	[FlyStrt Curlimit] Used to determine when the drive has matched the motor frequency if flying start is enabled.	30/200%	1%	150%
A547	[Compensation] Enables/disables correction options that may improve problems with motor instability.	0/3	0 = "Disabled" 1 = "Electrical" 2 = "Mechanical" 3 = "Both"	1 = "Electrical"
A548	[Power Loss Mode] Sets the reaction to a loss of input power.	0/1	0 = "Coast" 1 = "Decel"	0 = "Coast"
A549	[Half Bus Enable] Enables/disables the power ride through function which allows the drive to maintain power to the motor at 50% drive input voltage during short-term power sag conditions. <b>ATTENTION:</b> To guard against drive damage, a minimum line impedance must be provided to limit inrush current when the power line recovers. The input impedance should be equal or greater than the equivalent of a 5% transformer with a VA rating 6 times the drive's input VA rating if Half Bus is enabled.	0/1	0 = "Disabled" 1 = "Enabled"	0 = "Disabled"
A550	[Bus Reg Enable] Enables/disables the bus regulator.	0/1	0 = "Disabled" 1 = "Enabled"	1 = "Enabled"

 = Stop drive before changing this parameter.

 (PF 525) = Parameter is specific to PowerFlex 525 drives only.

No.	Parameter	Min/Max	Display/Options	Default
A551	[Fault Clear]	0/2	0 = "Ready/Idle" 1 = "Reset Fault" 2 = "Clear Buffer"	0 = "Ready/Idle"
	Resets a fault and clears the fault queue.			
A552	[Program Lock]	0000/9999	1111	0000
	Protects parameters against change by unauthorized personnel with a 4-digit password.			
A553	[Program Lock Mod]	0/3	0 = "Full Lock" 1 = "Keypad Lock" 2 = "Custom Only" 3 = "KeyPd Custom"	0 = "Full Lock"
	Determines the lock mode used in parameter A552 [Program Lock]. When set to 2 or 3, A552 [Program Lock] is added to the custom group to allow unlocking of parameters.			
A554	[Drv Ambient Sel]	0/4	0 = "Normal" 1 = "55C" 2 = "60C" 3 = "65C + Fan Kit" 4 = "70C + Fan Kit"	0 = "Normal"
	Sets the maximum expected ambient of the drive when used above 50 °C. When ambient temperature is above 50 °C, the drive will apply necessary current derating.			
A555	[Reset Meters]	0/2	0 = "Ready/Idle" 1 = "Reset Meters" 2 = "Reset Time"	0 = "Ready/Idle"
	Resets the values stored in the parameters that track fault times and energy usage.			
A556	[Text Scroll]	0/3	0 = "Off" 1 = "Low Speed" 2 = "Mid Speed" 3 = "High Speed"	2 = "Mid Speed"
	Sets the scrolling speed of the text in the LCD display.			
A557	[Out Phas Loss En]	0/1	0 = "Disabled" 1 = "Enabled"	0 = "Disabled"
	Enable/disable output phase loss detection. <b>ATTENTION:</b> Equipment damage and/or personal injury may result if this parameter is used in an inappropriate application. Do not use this function without considering applicable local, national and international codes, standards, regulations or industry guidelines.			
A558	[Positioning Mode]	0/4	0 = "Time Steps" 1 = "Preset Input" 2 = "Step Logic" 3 = "Preset Stpl" 4 = "StpLogic-Lst"	0 = "Time Steps"
 (PF 525)	Defines the positioning transition mode used for the position steps.			
A559	[Counts Per Unit]	1/32000	1	4096
(PF 525)	Sets the number of encoder counts equal to one user-defined unit.			
A560	[Enh Control Word]	0000 0000/1111 1111	Digit 8    Digit 7 Logic In 2    Logic In 1 Digit 6    Digit 5 Traverse Dis    Sync Enable Digit 4    Digit 3 Pos Redefine    Hold Step Digit 2    Digit 1 Find Home    Home Limit	0000 0000
(PF 525)	Allows control of positioning and other functions through parameter control for use over comms. The functions replicate the digital input options and function in the same way.			
A561	[Home Save]	0/1	0 = "Home Reset" 1 = "Home Saved"	0 = "Home Reset"
(PF 525)	Determines whether the current position is saved on power down.			
A562	[Find Home Freq]	0.1/500.0 Hz	0.1 Hz	10.0 Hz
(PF 525)	Sets the maximum frequency the drive uses when "Find Home" is issued.			
A563	[Find Home Dir]	0/1	0 = "Forward" 1 = "Reverse"	0 = "Forward"
 (PF 525)	Sets the direction the drive commands when "Find Home" is issued.			
A564	[Encoder Pos Tol]	1/50000	1	100
(PF 525)	Sets the "At Position" and the "At Home" tolerance around the encoder count. The value is added to and subtracted from the target encoder unit value to create the tolerance range.			
A565	[Pos Reg Filter]	0/15	1	8
(PF 525)	Sets the error signal filter in the position regulator.			

 = Stop drive before changing this parameter.

 (PF 525) = Parameter is specific to PowerFlex 525 drives only.

No.	Parameter	Min/Max	Display/Options	Default
A566 (PF 525)	[Pos Reg Gain] Sets the gain adjustment for the position regulator.	0.0/200.0	0.1	3.0
A567	[Max Traverse] Sets the amplitude of triangle wave speed modulation.	0.00/300.00 Hz	0.01 Hz	0.00 Hz
A568	[Traverse Inc] Sets the time required for the Traverse function to accelerate from the minimum to the maximum traverse frequency. See the diagram at A567 [Max Traverse].	0.00/300.00 s	0.01 s	0.00 s
A569	[Traverse Dec] Sets the time required for the Traverse function to decelerate from the maximum to the minimum traverse frequency. See the diagram at A567 [Max Traverse].	0.00/300.00 s	0.01 s	0.00 s
A570	[P Jump] Sets the frequency amplitude that is added to or subtracted from the commanded frequency. See the diagram at A567 [Max Traverse].	0.00/300.00 Hz	0.01 Hz	0.00 Hz
A571	[Sync Time] Enables the function that holds the drive at the current frequency even if the commanded frequency changes. Used with t062, t063, t065-t068 [DigIn TermBlk xx] 32 "Sync Enable".	0.0/3200.0 s	0.1 s	0.0 s
A572 	[Speed Ratio] Scales the drive speed command.	0.01/99.99	0.01	1.00
A573	[Mtr Options Cfg] Sets the configuration of the motor option.	00/11	Digit 2    Digit 1 ZeroSpd Slip    Jerk Select	11

## Fault Codes

No.	Fault	Action
F000	No Fault	—
F002	Auxiliary Input	<ul style="list-style-type: none"> <li>Check remote wiring.</li> <li>Verify communications programming for intentional fault.</li> </ul>
F003	Power Loss	<ul style="list-style-type: none"> <li>Monitor the incoming AC line for low voltage or line power interruption.</li> <li>Check input fuses.</li> <li>Reduce load.</li> </ul>
F004	UnderVoltage	Monitor the incoming AC line for low voltage or line power interruption.
F005	OverVoltage	Monitor the AC line for high line voltage or transient conditions. Bus overvoltage can also be caused by motor regeneration. Extend the decel time or install dynamic brake option.
F006	Motor Stalled	<ul style="list-style-type: none"> <li>Increase P041, A442, A444, A446 [Accel Time x] or reduce load so drive output current does not exceed the current set by parameter A484, A485 [Current Limit x] for too long.</li> <li>Check for overhauling load.</li> </ul>
F007	Motor Overload	<ul style="list-style-type: none"> <li>An excessive motor load exists. Reduce load so drive output current does not exceed the current set by parameter P033 [Motor OL Current].</li> <li>Verify A530 [Boost Select] setting.</li> </ul>
F008	Heatsink OvrTmp	<ul style="list-style-type: none"> <li>Check for blocked or dirty heat sink fins. Verify that ambient temperature has not exceeded the rated ambient temperature.</li> <li>Check fan.</li> </ul>
F009	CC OvrTmp	<ul style="list-style-type: none"> <li>Check product ambient temperature.</li> <li>Check for airflow obstruction.</li> <li>Check for dirt or debris.</li> <li>Check fan.</li> </ul>
F012	HW OverCurrent	Check programming. Check for excess load, improper A530 [Boost Select] setting, DC brake volts set too high or other causes of excess current.
F013	Ground Fault	Check the motor and external wiring to the drive output terminals for a grounded condition.
F015 <sup>(1)</sup>	Load Loss	<ul style="list-style-type: none"> <li>Verify connections between motor and load.</li> <li>Verify level and time requirements.</li> </ul>
F021	Output Ph Loss	<ul style="list-style-type: none"> <li>Verify motor wiring.</li> <li>Verify motor.</li> </ul>
F029	Analog In Loss	<ul style="list-style-type: none"> <li>Check for broken/loose connections at inputs.</li> <li>Check parameters.</li> </ul>

No.	Fault	Action
F033	Auto Rstrt Tries	Correct the cause of the fault and manually clear.
F038	Phase U to Gnd	<ul style="list-style-type: none"> <li>Check the wiring between the drive and motor.</li> <li>Check motor for grounded phase.</li> <li>Replace drive if fault cannot be cleared.</li> </ul>
F039	Phase V to Gnd	
F040	Phase W to Gnd	
F041	Phase UV Short	<ul style="list-style-type: none"> <li>Check the motor and drive output terminal wiring for a shorted condition.</li> <li>Replace drive if fault cannot be cleared.</li> </ul>
F042	Phase UW Short	
F043	Phase VW Short	
F048	Params Defaulted	<ul style="list-style-type: none"> <li>Clear the fault or cycle power to the drive.</li> <li>Program the drive parameters as needed.</li> </ul>
F059 <sup>(1)</sup>	Safety Open	Check safety input signals. If not using safety, verify and tighten jumper for I/O terminals S1, S2 and S+.
F063	SW OverCurrent	<ul style="list-style-type: none"> <li>Verify connections between motor and load.</li> <li>Verify level and time requirements.</li> </ul>
F064	Drive Overload	Reduce load or extend Accel Time.
F070	Power Unit	<ul style="list-style-type: none"> <li>Check maximum ambient temperature has not been exceeded.</li> <li>Cycle power.</li> <li>Replace drive if fault cannot be cleared.</li> </ul>
F071	DSI Net Loss	<ul style="list-style-type: none"> <li>Cycle power.</li> <li>Check communications cabling.</li> <li>Check Modbus or DSI setting.</li> <li>Check Modbus or DSI status.</li> </ul>
F072	Opt Net Loss	<ul style="list-style-type: none"> <li>Cycle power.</li> <li>Check communications cabling.</li> <li>Check network adapter setting.</li> <li>Check external network status.</li> </ul>
F073 <sup>(1)</sup>	EN Net Loss	<ul style="list-style-type: none"> <li>Cycle power.</li> <li>Check communications cabling.</li> <li>Check EtherNet/IP setting.</li> <li>Check external network status.</li> </ul>
F080	Autotune Failure	Restart procedure.
F081	DSI Comm Loss	<ul style="list-style-type: none"> <li>Cycle power.</li> <li>Check communications cabling.</li> <li>Check Modbus or DSI setting.</li> <li>Check Modbus or DSI status.</li> <li>Modify using C125 [Comm Loss Action].</li> <li>Connecting I/O terminals C1 and C2 to ground may improve noise immunity.</li> <li>Replace wiring, Modbus master device, or control module.</li> </ul>
F082	Opt Comm Loss	<ul style="list-style-type: none"> <li>Cycle power.</li> <li>Reinstall option card in drive.</li> <li>Modify using C125 [Comm Loss Action].</li> <li>Replace wiring, port expander, option card, or control module.</li> </ul>
F083 <sup>(1)</sup>	EN Comm Loss	<ul style="list-style-type: none"> <li>Cycle power.</li> <li>Check EtherNet/IP setting.</li> <li>Check drive's Ethernet settings and diagnostic parameters.</li> <li>Modify using C125 [Comm Loss Action].</li> <li>Replace wiring, Ethernet switch, or control module.</li> </ul>
F091 <sup>(1)</sup>	Encoder Loss	<ul style="list-style-type: none"> <li>Check Wiring.</li> <li>If P047, P049, P051 [Speed Referencex] = 16 "Positioning" and A535 [Motor Fdbk Type] = 5 "Quad Check", swap the Encoder channel inputs or swap any two motor leads.</li> <li>Replace encoder.</li> </ul>
F094	Function Loss	Close input to the terminal and cycle power.
F100	Parameter Chksum	Set P053 [Reset To Defaults] to 2 "Factory Rset".
F101	External Storage	Set P053 [Reset To Defaults] to 2 "Factory Rset".
F105	C Connect Err	Clear fault and verify all parameter settings. Do not remove or install the control module while power is applied.
F106	Incompat C-P	<ul style="list-style-type: none"> <li>Change to a different power module.</li> <li>Change to a PowerFlex 523 control module.</li> </ul>
F107	Replaced C-P	<ul style="list-style-type: none"> <li>Change to a different power module.</li> <li>Replace control module if changing power module does not work.</li> </ul>

No.	Fault	Action
F109	Mismatch C-P	Set P053 [Reset To Defaults] to 3 "Power Reset".
F110	Keypad Membrane	<ul style="list-style-type: none"> <li>• Cycle power.</li> <li>• Replace control module if fault cannot be cleared.</li> </ul>
F111 <sup>(1)</sup>	Safety Hardware	<ul style="list-style-type: none"> <li>• Check safety input signals. If not using safety, verify and tighten jumper for I/O terminals S1, S2 and S+.</li> <li>• Replace control module if fault cannot be cleared.</li> </ul>
F114	uC Failure	<ul style="list-style-type: none"> <li>• Cycle power.</li> <li>• Replace control module if fault cannot be cleared.</li> </ul>
F122	I/O Board Fail	<ul style="list-style-type: none"> <li>• Cycle power.</li> <li>• Replace drive or control module if fault cannot be cleared.</li> </ul>
F125	Flash Update Req	Perform a firmware flash update operation to attempt to load a valid set of firmware.
F126	NonRecoverablErr	<ul style="list-style-type: none"> <li>• Clear fault or cycle power to the drive.</li> <li>• Replace drive or control module if fault cannot be cleared.</li> </ul>
F127	DSIFlashUpdatReq	Perform a firmware flash update operation using DSI communications to attempt to load a valid set of firmware.

(1) This fault is not applicable to PowerFlex 523 drives.

## Drive Ratings

### PowerFlex 523 Frames – Ratings are in kW and (HP).

Frame	1-Phase 100...120V	1-Phase 200...240V	1-Phase 200...240V w/ Filter	3-Phase 200...240V	3-Phase 380...480V	3-Phase 380...480V w/ Filter	3-Phase 525...600V
A	0.2...0.4 (0.25...0.5)	0.2...0.75 (0.25...1.0)	0.2...0.75 (0.25...1.0)	0.2...2.2 (0.25...3.0)	0.4...2.2 (0.5...3.0)	0.4...2.2 (0.5...3.0)	0.4...2.2 (0.5...3.0)
B	0.75...1.1 (1.0...1.5)	1.5...2.2 (2.0...3.0)	1.5...2.2 (2.0...3.0)	4.0 (5.0)	4.0 (5.0)	4.0 (5.0)	4.0 (5.0)
C	–	–	–	5.5 (7.5)	5.5...7.5 (7.5...10.0)	5.5...7.5 (7.5...10.0)	5.5...7.5 (7.5...10.0)
D	–	–	–	7.5 (10.0)	11.0...15.0 (15.0...20.0)	11.0...15.0 (15.0...20.0)	11.0...15.0 (15.0...20.0)
E	–	–	–	11.0...15.0 (15.0...20.0)	–	18.5...22.0 (25.0...30.0)	18.5...22.0 (25.0...30.0)

### PowerFlex 525 Frames – Ratings are in kW and (HP).

Frame	1-Phase 100...120V	1-Phase 200...240V	1-Phase 200...240V w/ Filter	3-Phase 200...240V	3-Phase 380...480V	3-Phase 380...480V w/ Filter	3-Phase 525...600V
A	0.4 (0.5)	0.4...0.75 (0.5...1.0)	0.4...0.75 (0.5...1.0)	0.4...2.2 (0.5...3.0)	0.4...2.2 (0.5...3.0)	0.4...2.2 (0.5...3.0)	0.4...2.2 (0.5...3.0)
B	0.75...1.1 (1.0...1.5)	1.5...2.2 (2.0...3.0)	1.5...2.2 (2.0...3.0)	4.0 (5.0)	4.0 (5.0)	4.0 (5.0)	4.0 (5.0)
C	–	–	–	5.5 (7.5)	5.5...7.5 (7.5...10.0)	5.5...7.5 (7.5...10.0)	5.5...7.5 (7.5...10.0)
D	–	–	–	7.5 (10.0)	11.0...15.0 (15.0...20.0)	11.0...15.0 (15.0...20.0)	11.0...15.0 (15.0...20.0)
E	–	–	–	11.0...15.0 (15.0...20.0)	–	18.5...22.0 (25.0...30.0)	18.5...22.0 (25.0...30.0)

# Dimensions and Weight

IP 20/Open Type – Dimensions are in mm and (in.). Weights are in kg and (lb).

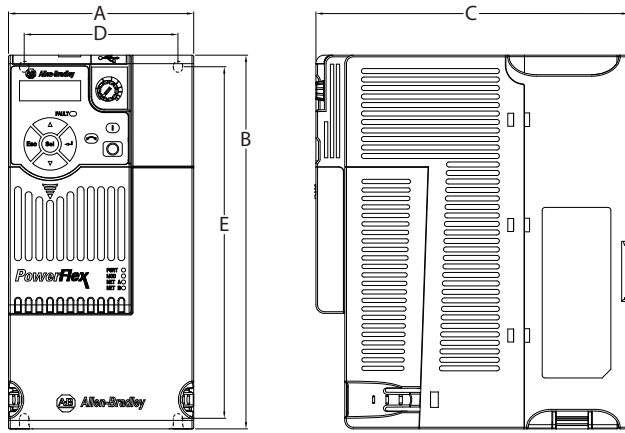

Frame Size	A	B	C	D	E	Weight
A	72.0 (2.83)	152.0 (5.98)	172.0 (6.77)	57.5 (2.26)	140.0 (5.51)	1.1 (2.4)
B	87.0 (3.43)	180.0 (7.09)	172.0 (6.77)	72.5 (2.85)	168.0 (6.61)	1.6 (3.5)
C	109.0 (4.29)	220.0 (8.66)	184.0 (7.24)	90.5 (3.56)	207.0 (8.15)	2.3 (5.0)
D	130.0 (5.12)	260.0 (10.24)	212.0 (8.35)	116.0 (4.57)	247.0 (9.72)	3.9 (8.6)
E	185.0 (7.28)	300.0 (11.81)	279.0 (10.98)	160.0 (6.30)	280.0 (11.02)	12.9 (28.4)

EMC Line Filter – Dimensions are in mm and (in.).

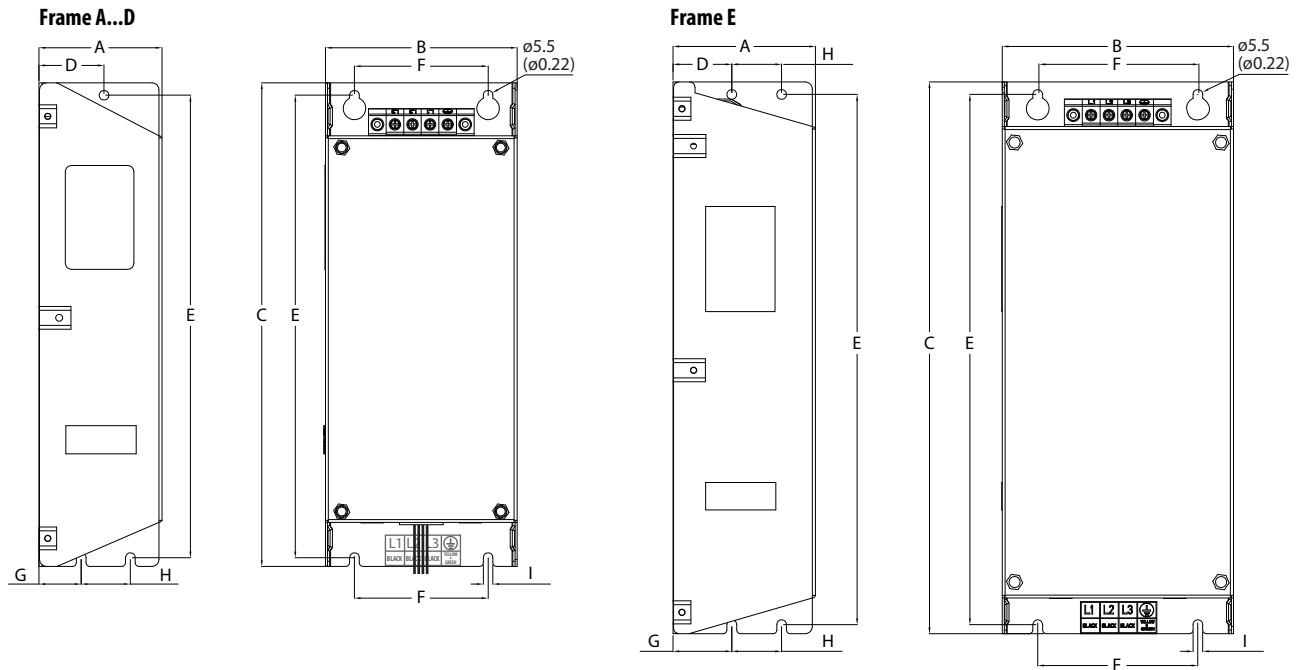

Frame Size <sup>(1)</sup>	A	B	C	D	E	F	G	H	I
A	55.0 (2.17)	72.0 (2.83)	234.0 (9.21)	30.0 (1.18)	223.0 (8.78)	54.0 (2.13)	20.0 (0.79)	23.0 (0.91)	5.5 (0.22)
B	70.0 (2.76)	87.0 (3.43)	270.0 (10.63)	35.0 (1.38)	258.0 (10.16)	58.0 (2.28)	25.0 (0.98)	24.0 (0.94)	5.5 (0.22)
C	70.0 (2.76)	109.0 (4.29)	275.0 (10.83)	37.0 (1.46)	263.0 (10.35)	76.0 (2.99)	25.0 (0.98)	28.0 (1.10)	5.5 (0.22)
D	80.0 (3.15)	130.0 (5.12)	310.0 (12.20)	33.0 (1.30)	298.0 (11.73)	90.0 (3.54)	33.0 (1.30)	28.0 (1.10)	5.5 (0.22)
E	80.0 (3.15)	155.0 (6.10)	390.0 (15.35)	33.0 (1.30)	375.0 (14.76)	110.0 (4.33)	33.0 (1.30)	28.0 (1.10)	5.5 (0.22)

(1) See the PowerFlex 520-Series Adjustable Frequency AC Drive User Manual, publication [520-UM001](#) for instructions on complying with the EMC Directive.



# Network Communication

## PowerFlex 520-Series RS784 (DSI) Protocol

This section contains only basic information to setup the PowerFlex 520-series RS485 (DSI) protocol connection with your PowerFlex 520-series drive. See the PowerFlex 520-Series Adjustable Frequency AC Drive User Manual, publication [520-UM001](#) for more information.

PowerFlex 520-series drives support the RS485 (DSI) protocol to allow efficient operation with Rockwell Automation peripherals. In addition, some Modbus functions are supported to allow simple networking. PowerFlex 520-series drives can be multi-dropped on an RS485 network using Modbus protocol in RTU mode.

### PowerFlex 520-Series Drive Network

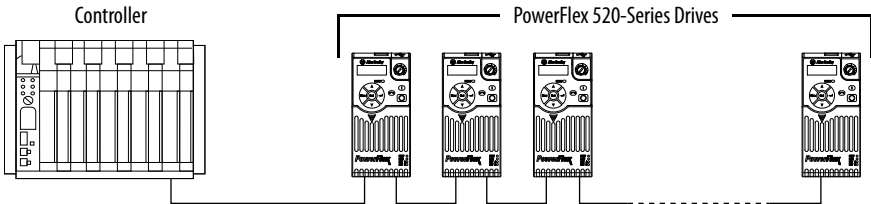

### Network Wiring

Network wiring consists of a shielded 2-conductor cable that is daisy-chained from node to node.



**ATTENTION:** Never attempt to connect a Power over Ethernet (PoE) cable to the RS485 port. Doing so may damage the circuitry.

### Network Wiring Diagram Example

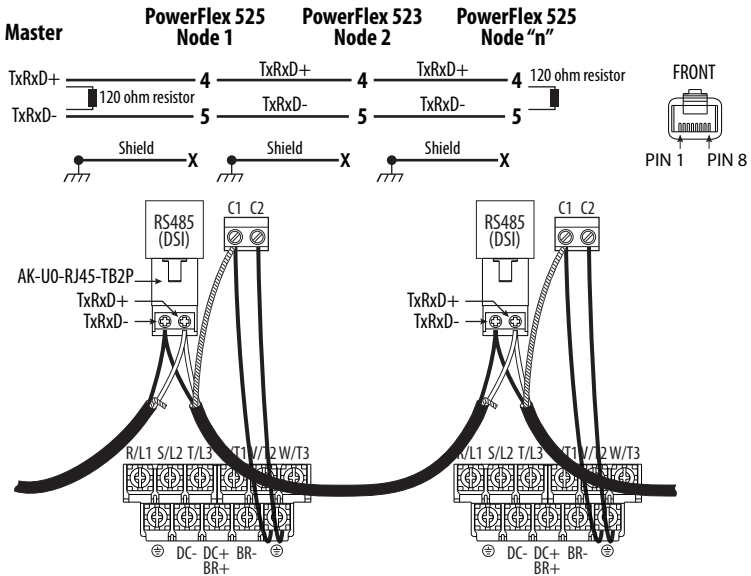

**IMPORTANT** The shield is connected at **ONLY ONE** end of each cable segment.

The following PowerFlex 520-series drive parameters are used to configure the drive to operate on a DSI network.

**Configuring Parameters for DSI Network**

Parameter	Description
P046 [Start Source 1]	Set to 3 "Serial/DSI" if Start is controlled from the network
P047 [Speed Reference 1]	Set to 3 "Serial/DSI" if Speed Reference is controlled from the network.
C123 [RS485 Data Rate]	Sets the data rate for the RS485 (DSI) port. All nodes on the network must be set to the same data rate.
C124 [RS485 Node Addr]	Sets the node address for the drive on the network. Each device on the network requires a unique node address.
C125 [Comm Loss Action]	Selects the drive's response to communication problems.
C126 [Comm Loss Time]	Sets the time that the drive will remain in communication loss before the drive implements C125 [Comm Loss Action].
C127 [Comm Format]	Sets the transmission mode, data bits, parity, and stop bits for the RS485 (DSI) port. All nodes on the network must be set to the same setting.
C128 [Comm Write Mode]	Set to 0 "Save" when programming drive. Set to 1 "RAM only" to only write to volatile memory.

**PowerFlex 525 Embedded EtherNet/IP**

This section contains only basic information to setup an EtherNet/IP connection with your PowerFlex 525 drive. For comprehensive information about EtherNet/IP (single and dual-port) and how to use it, see the following publications:

- PowerFlex 525 Embedded EtherNet/IP Adapter User Manual, publication [520COM-UM001](#).
- PowerFlex 25-COMM-E2P Dual-Port EtherNet/IP Adapter User Manual, publication [520COM-UM003](#).

*Connecting the Adapter to the Network*



**ATTENTION:** Risk of injury or death exists. The PowerFlex drive may contain high voltages that can cause injury or death. Remove power from the drive, and then verify power has been discharged before connecting the embedded EtherNet/IP adapter to the network.

1. Remove power from the drive.
2. Remove the drive control module cover.
3. Use static control precautions.
4. Connect one end of an Ethernet cable to the EtherNet/IP network.

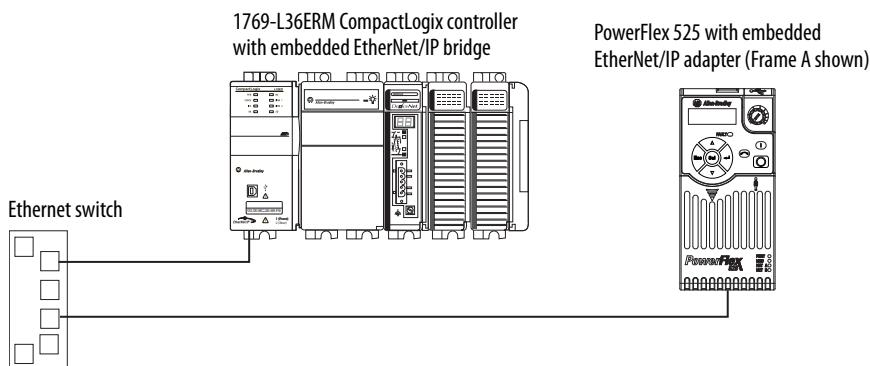

5. Route the other end of the Ethernet cable through the bottom of the PowerFlex 525 drive, and insert the cable's plug into the embedded EtherNet/IP adapter's mating socket.

**Drive and Adapter Status Indicators**

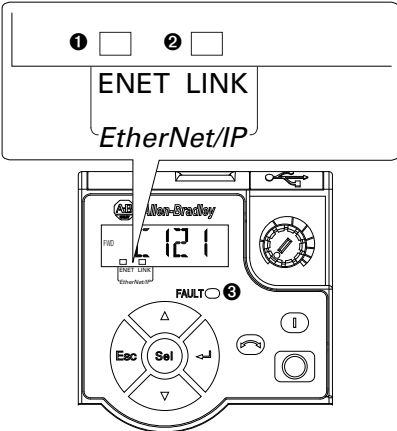

Item	Name	State	Description
❶	ENET	Off	Adapter is not connected to the network
		Steady	Adapter is connected to the network and drive is controlled through Ethernet.
		Flashing	Adapter is connected to the network but drive is not controlled through Ethernet.
❷	LINK	Off	Adapter is not connected to the network.
		Steady	Adapter is connected to the network but not transmitting data.
		Flashing	Adapter is connected to the network and transmitted data.
❸	FAULT	Flashing Red	Indicates drive is faulted.

**Setting the IP Address, Subnet Mask, and Gateway Address**

Setting an IP Addresss Using Parameters

1. Verify that parameter C128 [EN Addr Sel] is set to 1 “Parameters”.  
This parameter must be set to “Parameters” to configure the IP address using parameters.
2. Set the value of parameters C129 [EN IP Addr Cfg 1] through C132 [EN IP Addr Cfg 4] to a unique IP address.
3. Reset the adapter by power cycling the drive.

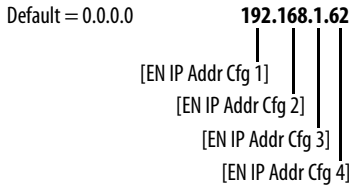

Setting a Subnet Mask Using Parameters

1. Verify that parameter C128 [EN Addr Sel] is set to 1 “Parameters”.  
This parameter must be set to “Parameters” to configure the subnet mask using parameters.
2. Set the value of parameters C133 [EN Subnet Cfg 1] through C136 [EN Subnet Cfg 4] to the desired value for the subnet mask.
3. Reset the adapter by power cycling the drive.

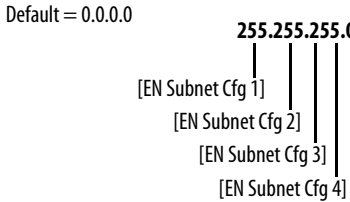

Setting a Gateway Addresss Using Parameters

1. Verify that parameter C128 [EN Addr Sel] is set to 1 “Parameters”.  
This parameter must be set to “Parameters” to configure the gateway address using parameters.
2. Set the value of parameters C137 [EN Gateway Cfg 1] through C140 [EN Gateway Cfg 4] to desired value for the gateway address.
3. Reset the adapter by power cycling the drive.

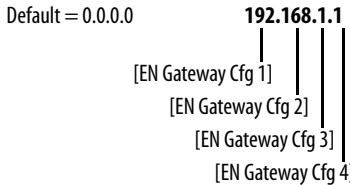

## Important Information

Solid-state equipment has operational characteristics differing from those of electromechanical equipment. Safety Guidelines for the Application, Installation and Maintenance of Solid State Controls (publication [SGI-1.1](#) available from your local Rockwell Automation sales office or online at <http://www.rockwellautomation.com/literature/>) describes some important differences between solid-state equipment and hard-wired electromechanical devices. Because of this difference, and also because of the wide variety of uses for solid-state equipment, all persons responsible for applying this equipment must satisfy themselves that each intended application of this equipment is acceptable.

In no event will Rockwell Automation, Inc. be responsible or liable for indirect or consequential damages resulting from the use or application of this equipment.

The examples and diagrams in this publication are included solely for illustrative purposes. Because of the many variables and requirements associated with any particular installation, Rockwell Automation, Inc. cannot assume responsibility or liability for actual use based on the examples and diagrams.

No patent liability is assumed by Rockwell Automation, Inc. with respect to use of information, circuits, equipment, or software described in this manual.

Reproduction of the contents of this manual, in whole or in part, without written permission of Rockwell Automation, Inc., is prohibited.

## Documentation Feedback

Your comments will help us serve your documentation needs better. If you have any suggestions on how to improve this document, complete this form, publication [RA-DU002](#), available at <http://www.rockwellautomation.com/literature/>.

Allen-Bradley, Rockwell Software, Rockwell Automation, PowerFlex, Connected Components Workbench, Studio 5000, DriveTools SP, AppView, CustomView, MainsFree Programming, and PointStop are trademarks of Rockwell Automation, Inc.

Trademarks not belonging to Rockwell Automation are property of their respective companies.

**[www.rockwellautomation.com](http://www.rockwellautomation.com)**

---

### Power, Control and Information Solutions Headquarters

Americas: Rockwell Automation, 1201 South Second Street, Milwaukee, WI 53204-2496 USA, Tel: (1) 414.382.2000, Fax: (1) 414.382.4444

Europe/Middle East/Africa: Rockwell Automation NV, Pegasus Park, De Kleetlaan 12a, 1831 Diegem, Belgium, Tel: (32) 2 663 0600, Fax: (32) 2 663 0640

Asia Pacific: Rockwell Automation, Level 14, Core F, Cyberport 3, 100 Cyberport Road, Hong Kong, Tel: (852) 2887 4788, Fax: (852) 2508 1846